

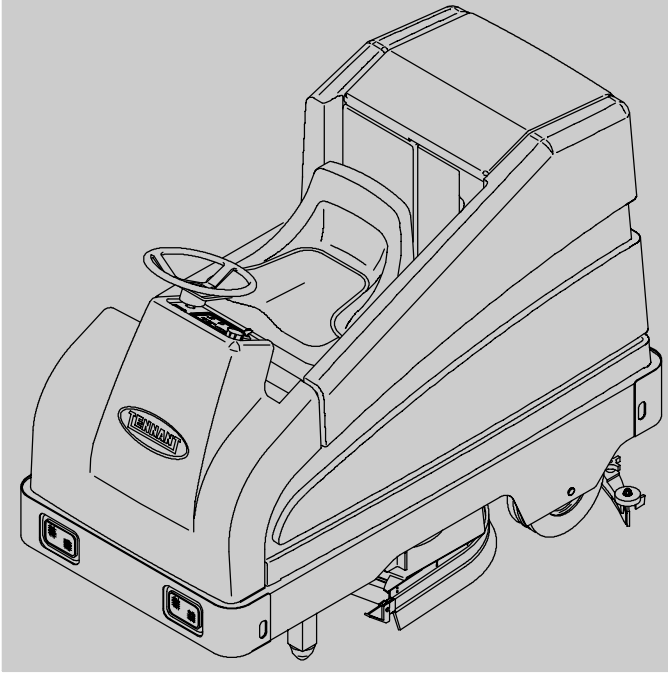

T15

(Electric)

Rider Scrubber Operator Manual



The Safe Scrubbing Alternative®

ES® Extended Scrub System



North America / International

www.tennantco.com

331550
Rev. 03 (02-2009)





This manual is furnished with each new model. It provides necessary operation and maintenance instructions.

Read this manual completely and understand the machine before operating or servicing it.

This machine will provide excellent service. However, the best results will be obtained at minimum costs if:

- The machine is operated with reasonable care.
- The machine is maintained regularly - per the machine maintenance instructions provided.
- The machine is maintained with manufacturer supplied or equivalent parts.

| | |
|---|--|
|  | PROTECT THE ENVIRONMENT Please dispose of packaging materials, old machine components such as batteries, hazardous fluids including antifreeze and oil, in an environmentally safe way according to local waste disposal regulations. Always remember to recycle. |
|  | |

| | |
|---|-------|
| MACHINE DATA | |
| Please fill out at time of installation for future reference. | |
| Model No. - | _____ |
| Serial No. - | _____ |
| Machine Options - | _____ |
| Sales Rep. - | _____ |
| Sales Rep. phone no. - | _____ |
| Customer Number - | _____ |
| Installation Date - | _____ |

Tennant Company
PO Box 1452
Minneapolis, MN 55440
Phone: (800) 553-8033 or (763) 513-2850
www.tennantco.com

ES , Pre-Sweep, FaST-PAK, Smart Release, Touch-N-Go Control Panel, 1-Step, and Lower Total Cost of Ownership are US registered and unregistered trademarks of Tennant Company.

Specifications and parts are subject to change without notice.

Original Instructions, copyright © 2007, 2008, and 2009 TENNANT, Printed in U.S.A.

CONTENTS

| | Page | | Page |
|---------------------------------------|------|--|------|
| Safety Precautions | 3 | Positive Drain Control Valve | 55 |
| Operation | 5 | Rollout Battery | 56 |
| Machine Components | 5 | Machine Troubleshooting | 61 |
| Control Panel Symbols | 6 | Maintenance | 63 |
| Controls And Instruments | 7 | Maintenance Chart | 63 |
| Operation Of Controls | 8 | Lubrication | 65 |
| Directional Pedal | 8 | Steering Caster Pivot Bearing | 65 |
| Brake Pedal | 9 | Rear Squeegee Casters | 65 |
| Parking Brake | 9 | Steering Gear Chain | 65 |
| Key Switch | 10 | Batteries | 66 |
| Power Kill Switch | 10 | Charging The Batteries | 67 |
| Operating Lights Switch | 10 | Self-diagnostic Test | 70 |
| Hourmeter | 10 | Electric Motors | 72 |
| Operator Seat | 11 | Pre-sweep Brushes | 72 |
| Seat Support Arm | 11 | Pre-sweep Disk Brushes | 72 |
| Solution Flow Lever | 11 | Replacing The Disk Brushes | 72 |
| Scrubbing Switch | 12 | Pre-sweep Cylindrical Brush | 74 |
| Squeegee Switch | 13 | Checking And Adjusting Cylindrical | |
| ES Switch (Option) | 13 | Brush Pattern | 74 |
| FaST Switch (Option) | 13 | Replacing The Pre-sweep | |
| ec-H2O Switch (Option) | 14 | Cylindrical Brush | 76 |
| Recovery Tank Full Indicator | 14 | Scrub Brushes | 78 |
| Battery Discharge Indicator | 15 | Disk Scrub Brushes | 78 |
| Pre-sweep Switch (Option) | 16 | Replacing The Disk Scrub Brushes | 78 |
| Dust Control Switch (Option) | 16 | Cylindrical Scrub Brushes | 81 |
| Side Brush Pedals (Option) | 16 | Checking And Adjusting Cylindrical | |
| Circuit Breakers | 17 | Scrub Brush Pattern | 81 |
| Fuse | 18 | Replacing The Cylindrical | |
| Steering Wheel | 18 | Scrub Brushes | 84 |
| Squeegee Wheel Cams | 19 | Solution System | 86 |
| Squeegee Leveling Knob | 19 | Recovery Tank | 86 |
| Side Squeegee Down Pressure | | Solution Tank | 87 |
| Controls | 19 | FaST System | 87 |
| How The Machine Works | 20 | FaST Supply Hose Connector | 87 |
| Brush And Pad Information | 20 | FaST / Solution Filter Screen | 88 |
| FaST Scrubbing System | 22 | FaST System Air Pump Filter | |
| ec-H2O System (Option) | 23 | (S/N 000000-015437) | 88 |
| Pre-operation Checklist | 24 | FaST System Injector Filters | |
| Installing FaST PAK Agent | 25 | (S/N 015438-) | 88 |
| Starting The Machine | 26 | ec-H2O Module Flush Procedure | 89 |
| Filling The Tanks | 27 | Rear Squeegee Assembly | 90 |
| Scrubbing | 29 | Removing The Rear Squeegee | |
| Double Scrubbing | 33 | Assembly | 90 |
| Stop Scrubbing | 34 | Replacing The Rear Squeegee | |
| Draining And Cleaning The Tanks | 36 | Assembly | 91 |
| Stop The Machine | 40 | Leveling The Rear Squeegee | 91 |
| Options | 41 | Adjusting Rear Squeegee | |
| Side Brush | 41 | Blade Deflection | 92 |
| Pre-sweep Assembly | 42 | Adjusting The Squeegee Guide Roller | 93 |
| To Empty The Pre-sweep | | Rear Squeegee Blades | 93 |
| Debris Hopper | 43 | Replacing Or Rotating The | |
| To Remove The Pre-sweep | | Rear Squeegee Blade | 93 |
| Assembly | 45 | Replacing Or Rotating The | |
| To Mount The Pre-sweep Assembly | 46 | Front Squeegee Blade | 95 |
| Power Wand | 48 | Side Squeegee Blades | 96 |
| Vacuum Wand | 52 | Replacing Side Squeegee Blades | 96 |

CONTENTS

| | Page |
|--|------|
| Skirts And Seals | 97 |
| Pre-sweep Side Skirts (Option) | 97 |
| Pre-sweep Recirculation Skirt (Option) | 97 |
| Pre-sweep Rear Skirt (Option) | 97 |
| Belts And Chains | 98 |
| Scrub Brush Drive Belts | 98 |
| Pre-sweep Brush Motor Belt (Option) | 98 |
| Pre-sweep Brush Drive Belt (Option) | 98 |
| Static Drag Strap | 99 |
| Steering Gear Chain | 99 |
| Tires | 99 |
| Pushing, Towing, And Transporting | |
| The Machine | 100 |
| Pushing Or Towing The Machine .. | 100 |
| Transporting The Machine | 100 |
| Machine Jacking | 102 |
| Storage Information | 103 |
| Freeze Protection | 103 |
| ec-H2O Model | 104 |
| Flushing Antifreeze From | |
| The ec-H2O Module | 104 |
| Specifications | 105 |
| General Machine Dimensions/Capacities | 105 |
| General Machine Performance | 105 |
| Power Type | 106 |
| Tires | 106 |
| FaST System | 106 |
| ec-H2O System (Option) | 106 |
| Machine Dimensions | 107 |
| Index | 108 |

SAFETY PRECAUTIONS

The following symbols are used throughout this manual as indicated in their description:



WARNING: To warn of hazards or unsafe practices that could result in severe personal injury or death.

FOR SAFETY: To identify actions that must be followed for safe operation of equipment.

This machine is designed solely for scrubbing dirt and dust in an indoor environment. Tennant does not recommend using this machine in any other environment.

The following information signals potentially dangerous conditions to the operator or equipment. Read this manual carefully. Know when these conditions can exist. Locate all safety devices on the machine. Then, take necessary steps to train machine operating personnel. Report machine damage or faulty operation immediately. Do not use the machine if it is not in proper operating condition.



WARNING: Batteries emit hydrogen gas. Explosion or fire can result. Keep sparks and open flame away. Keep covers open when charging.



WARNING: Flammable materials can cause an explosion or fire. Do not use flammable materials in tank(s).



WARNING: Flammable materials or reactive metals can cause an explosion or fire. Do not pickup.

FOR SAFETY:

1. **Do not operate machine:**
 - Unless trained and authorized.
 - Unless operation manual is read and understood.
 - With brake disabled.
 - If it is not in proper operating condition.
 - In flammable or explosive areas unless designed for use in those areas.
 - In areas with possible falling objects unless equipped with overhead guard.

2. **Before starting machine:**
 - Make sure all safety devices are in place and operate properly.
 - Check brakes and steering for proper operation (if so equipped).
 - Adjust seat and fasten seat belt (if so equipped).
3. **When using machine:**
 - Do not pick up burning or smoking debris, such as cigarettes, matches or hot ashes
 - Go slow on inclines and slippery surfaces.
 - Use care when backing machine.
 - Do not carry passengers on machine.
 - Follow mixing and handling instructions on chemical containers.
 - Report machine damage or faulty operation immediately.
4. **Before leaving or servicing machine:**
 - Stop on level surface.
 - Turn off machine and remove key.
5. **When servicing machine:**
 - Avoid moving parts. Do not wear loose jackets, shirts, or sleeves when working on machine.
 - Block machine tires before jacking machine up.
 - Jack machine up at designated locations only. Block machine up with jack stands.
 - Use hoist or jack that will support the weight of the machine.
 - Wear eye and ear protection when using pressurized air or water.
 - Disconnect battery connections before working on machine.
 - Wear protective gloves and eye protection when handling vinegar.
 - Avoid contact with battery acid.
 - Use Tennant supplied or equivalent replacement parts.
6. **When loading/unloading machine onto/off truck or trailer.**
 - Turn off machine.
 - Use truck or trailer that will support the weight of the machine.
 - Use winch. Do not push the machine onto/off the truck or trailer unless the load height is 380 mm (15 in) or less from the ground.
 - Block machine tires.
 - Tie machine down to truck or trailer.

SAFETY PRECAUTIONS

The safety labels appear on the machine in the locations indicated. If these or any label becomes damaged or illegible, install a new label in its place.

BATTERY CHARGING LABEL - LOCATED ON AND UNDERNEATH THE SEAT SUPPORT.



FLAMMABLE MATERIALS LABEL - LOCATED ON THE UNDERSIDE OF THE TANK COVER AND ON THE LEFT SIDE OF THE OPERATOR COMPARTMENT.



FLAMMABLE SPILLS LABEL - LOCATED ON THE SEAT SUPPORT.



FOR SAFETY LABEL - LOCATED ON THE SEAT SUPPORT.

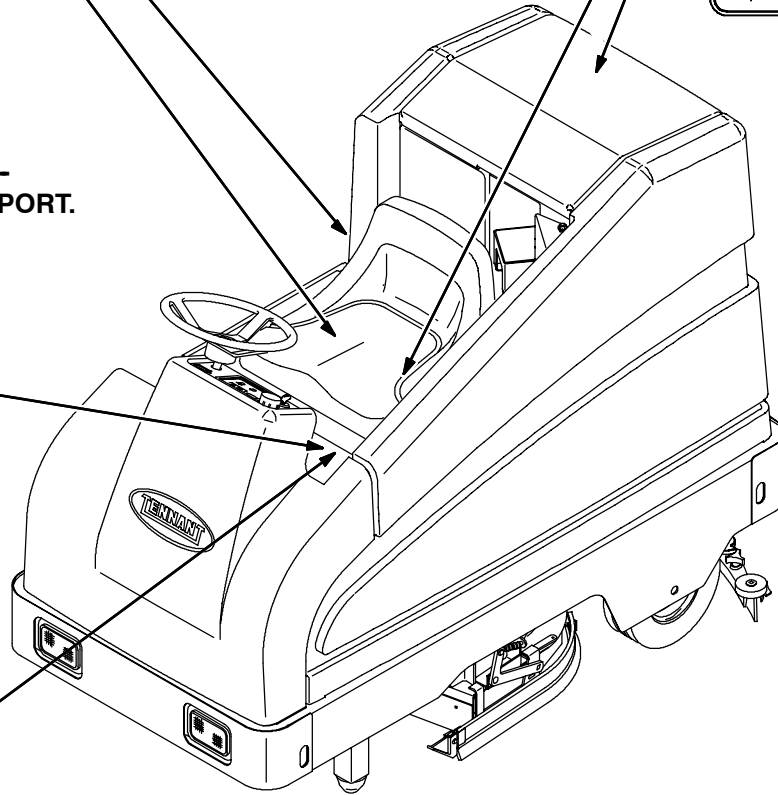

OPERATION

MACHINE COMPONENTS

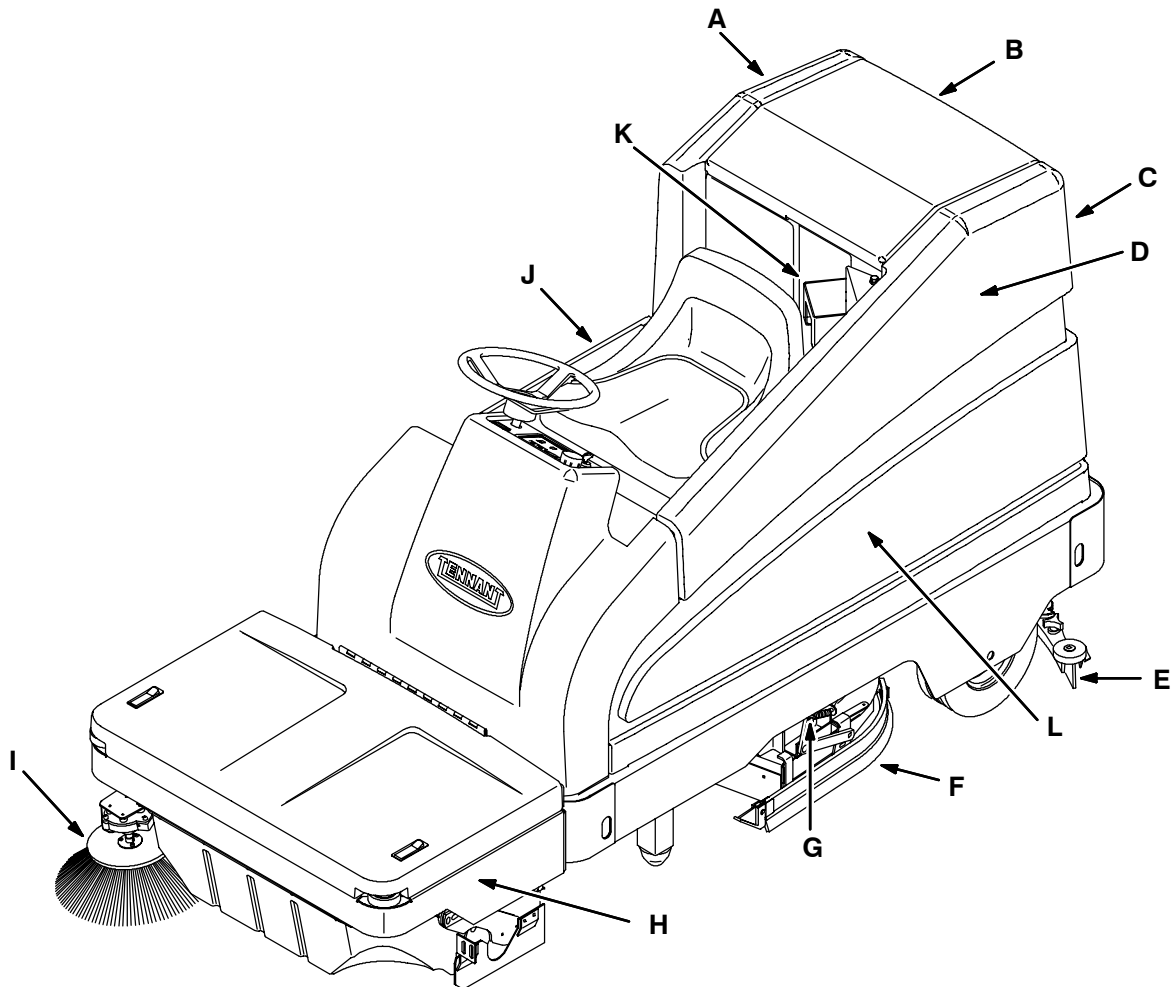

- A. Solution tank
- B. Tank Cover
- C. Recovery tank
- D. Vacuum fan inlet screen
- E. Rear squeegee
- F. Side squeegee
- G. Scrub head
- H. Pre-Sweep assembly (option)
- I. Pre-Sweep side brush (es) (option)
- J. Batteries
- K. FaST PAK (option)
ec-H2O System Module (option)
- L. FaST solution system

353673

OPERATION

CONTROL PANEL SYMBOLS

These symbols identify controls and displays on the machine:



Battery charge



Scrubbing



Squeegee



Brush pressure



ES - Extended Scrub (Option)



FaST (Option)



ec-H2O (Option)



Recovery tank full



Solution flow



Pre-Sweep (Option)



Dust control (Option)



Circuit breaker #1



Circuit breaker #2



Circuit breaker #3



Circuit breaker #4



Circuit breaker #5



Circuit breaker #6



Circuit breaker #7



Circuit breaker #8



Circuit breaker #9



Circuit breaker #10



Circuit breaker #11



Circuit breaker #12



Circuit breaker #13



Circuit breaker #14



Circuit breaker #15

CONTROLS AND INSTRUMENTS

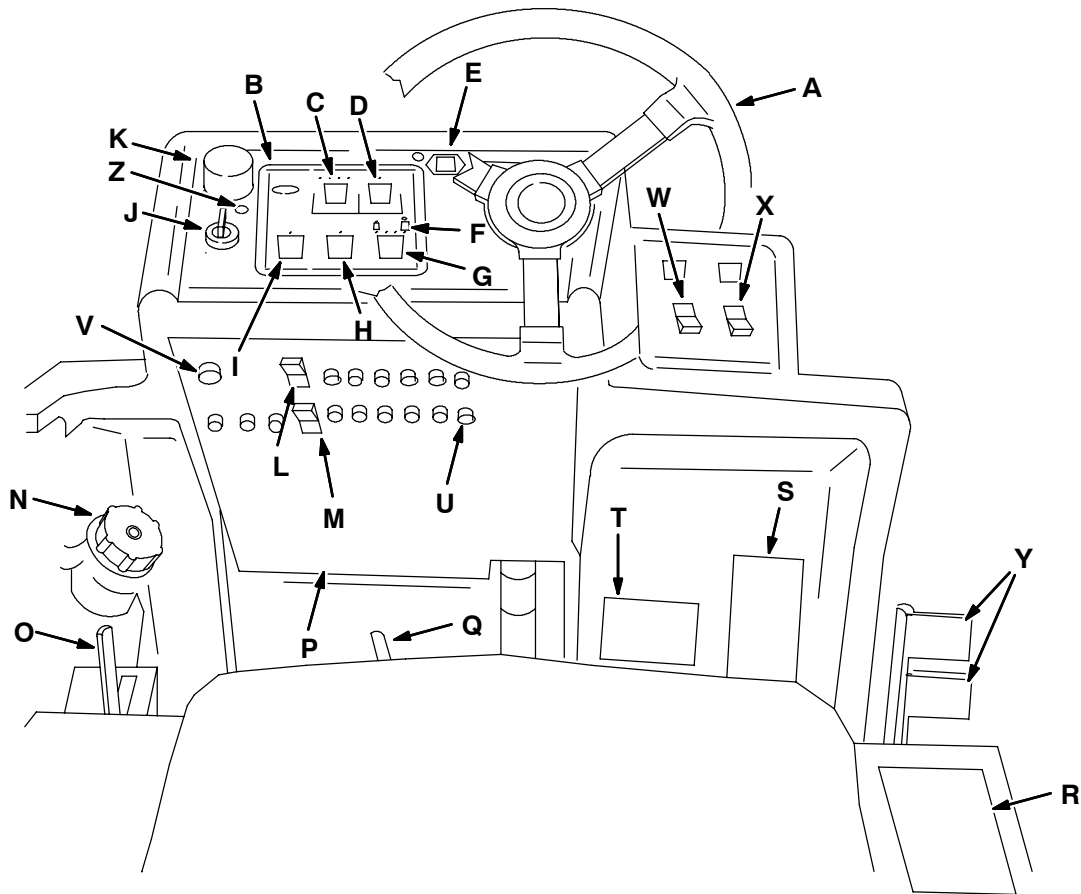

350655

- A. Steering wheel
- B. Control panel
- C. Battery discharge indicator
- D. Recovery tank full indicator
- E. Hourmeter
- F. Brush pressure indicator
- G. Scrubbing switch
- H. Squeegee switch
- I. ES (Extended Scrub) switch (option), FaST switch (option), ec-H2O system on/off switch (option)
- J. Key switch
- K. Power kill switch
- L. Operating lights switch
- M. Power wand switch (option)
- N. Recovery tank clean-out port
- O. Solution flow lever
- P. Operator console
- Q. Seat adjustment lever
- R. Use and care guide
- S. Directional pedal
- T. Brake pedal
- U. Circuit breakers
- V. Horn button
- W. Dust control switch (option)
- X. Pre-Sweep switch (option)
- Y. Side brush pedals (option)
- Z. ec-H2O indicator light (option)

OPERATION

OPERATION OF CONTROLS

DIRECTIONAL PEDAL

The directional pedal controls the machine's direction of travel and propelling speed. The machine's speed is controlled by the amount of pressure placed on the pedal; the farther the pedal is pressed, the faster the machine will travel.

Forward: Press the top of the directional pedal with the upper part of your foot.

NOTE: A seat switch is located under the operator seat. If there is no weight on the operator seat, the machine WILL NOT propel in any direction.

Reverse: Press the bottom of the directional pedal with the heel of your foot.

When the directional pedal is placed into the reverse position, the rear squeegee will automatically raise. After a short delay, the vacuum will stop.

Neutral: The machine will automatically return to the Neutral position when you take your foot off the directional pedal.

When the directional pedal returns to the neutral position, the scrub brushes will stop and after a short delay, the scrub head will raise.

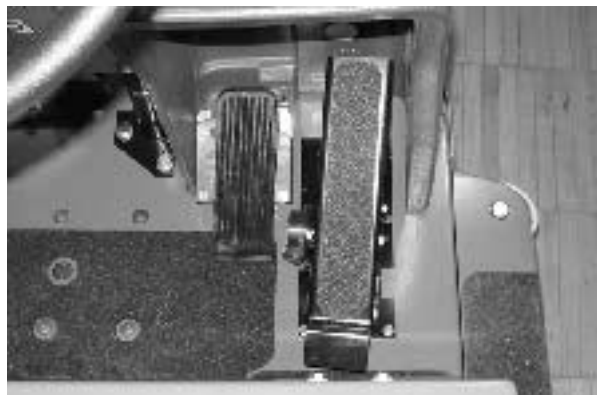
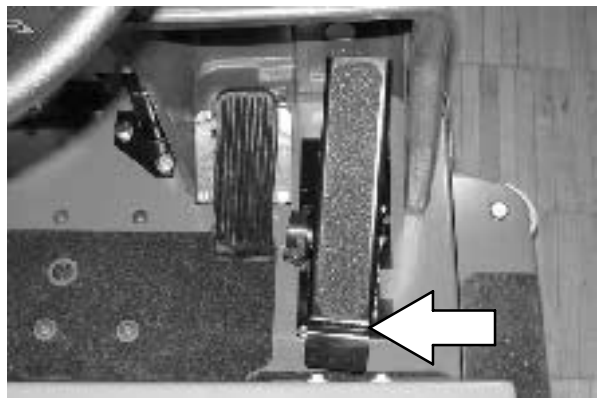
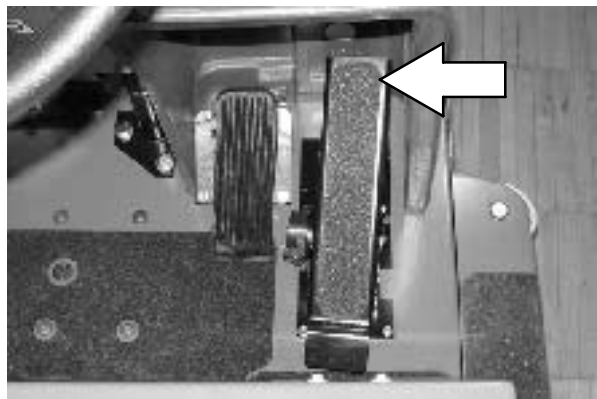
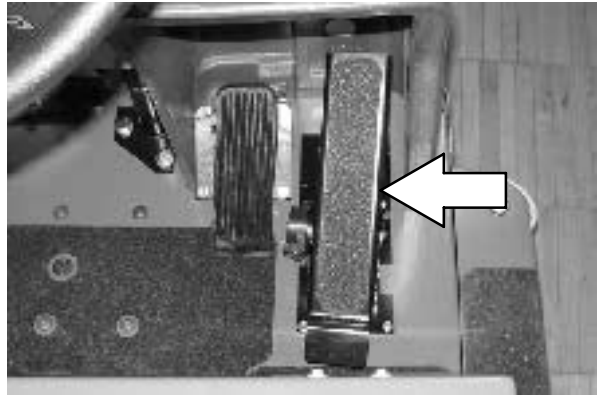

BRAKE PEDAL

Release the directional pedal to stop the machine. The *Brake Pedal* can be used to stop the machine if quicker stopping is needed on surfaces such as inclines. Do not operate the machine on inclines exceeding 8° with empty tanks or 4° with full tanks.

FOR SAFETY: When using machine, go slow on inclines and slippery surfaces.

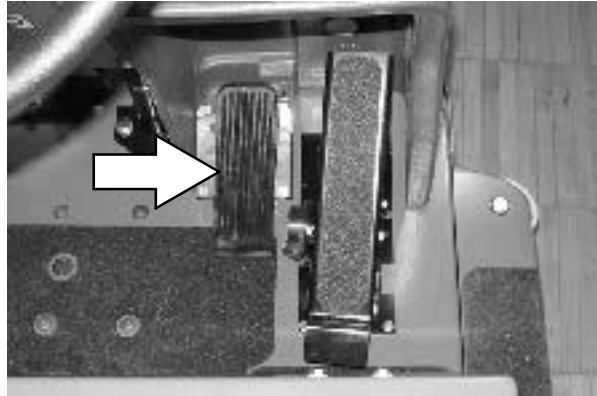
**PARKING BRAKE**

The *parking brake* on this machine is automatic and will engage approximately one second after the machine stops.

OPERATION

KEY SWITCH

The key switch turns the machine's power on and off.

On: Turn the key fully clockwise and release it to the on position.

Off: Turn the key to the left until it clicks.

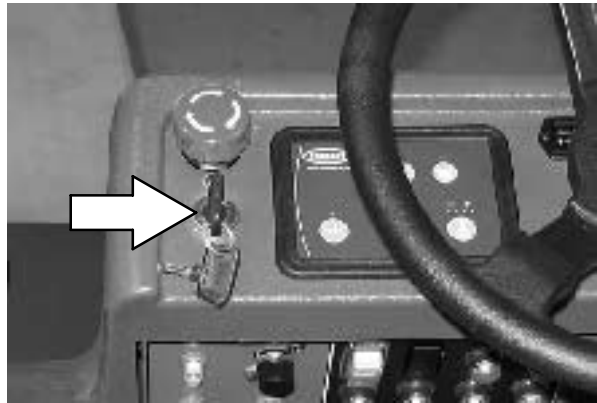

POWER KILL SWITCH

The power kill switch immediately stops all power to the machine.

Stop machine power: Press the power kill switch.

Restart machine power: Release the power kill switch by turning it to the right. Turn the key switch off, then turn the key fully clockwise and release it to the on position.

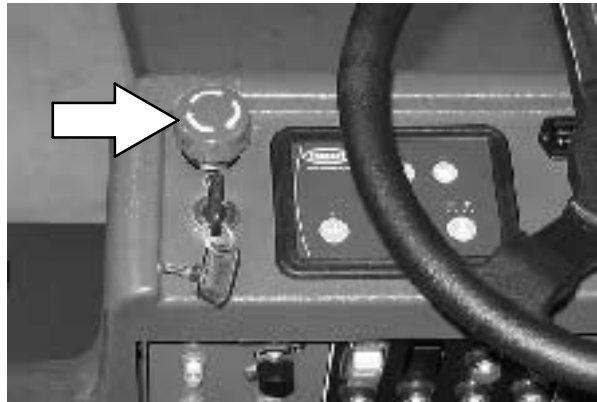

OPERATING LIGHTS SWITCH

The operating lights switch powers the headlights and taillights on and off.

On: Press the top of the operating lights switch.

Off: Press the bottom of the operating lights switch.

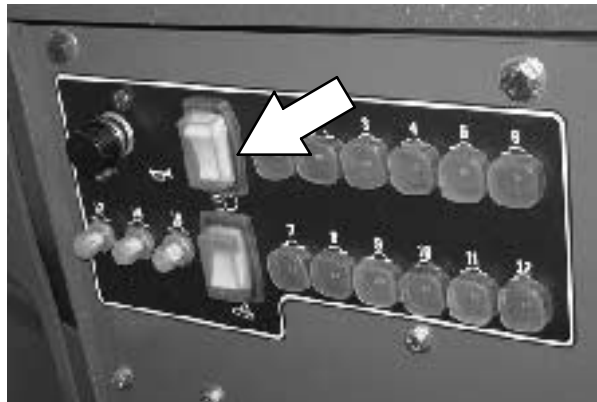

HOURMETER

The hourmeter records the number of hours the machine has been operated. Check the hourmeter regularly; this information is used to determine when to perform routine machine maintenance.

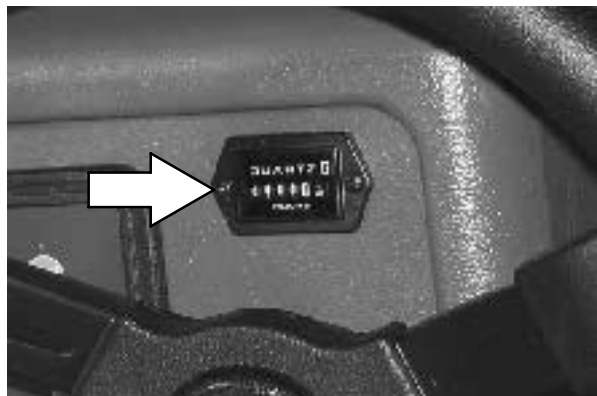

OPERATOR SEAT

The operator seat is designed to be adjusted forward and backward.

Adjust: Move the lever toward the center of the seat, slide the seat backward or forward to the desired position, and release the lever.

NOTE: A seat switch is located under the operator seat. If there is no weight on the operator seat, the machine **WILL NOT** propel in any direction.

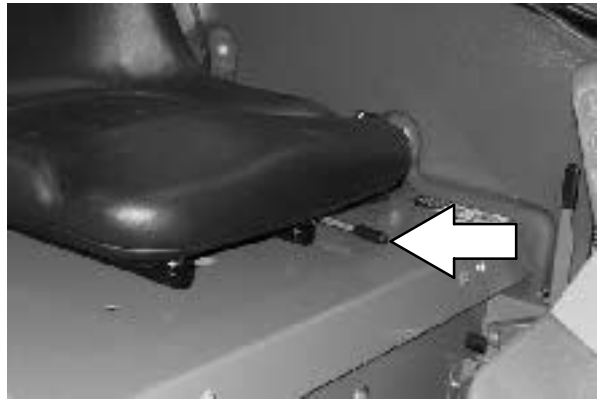

SEAT SUPPORT ARM

The seat support arm holds the seat up to allow access to the batteries. The support arm automatically engages when the seat is lifted all the way up. Lower the seat support by slightly raising it while pushing the support arm inward.

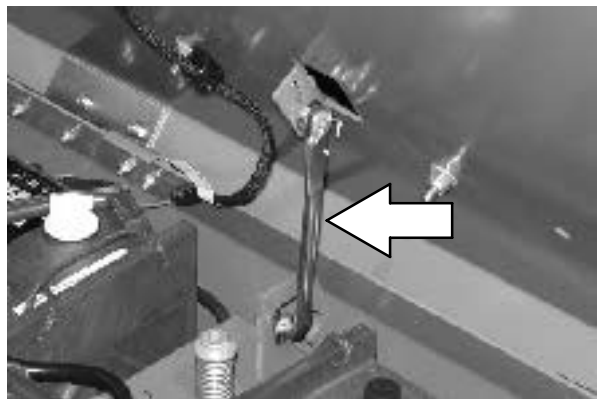

SOLUTION FLOW LEVER

The solution flow lever controls the amount of solution that flows to the floor while scrubbing.

Increase solution flow: Push the lever forward.

Decrease solution flow: Pull the lever backward.

NOTE: The machine is equipped with a solenoid valve that automatically stops the solution flow when the directional pedal is in the neutral position or when the scrub head is raised.

NOTE: When using the FaST or ec-H2O system (option), the solution flow lever is nonfunctional. The FaST and ec-H2O system flow rates are pre-set. The ec-H2O module has optional flow rate settings. If solution flow adjustments are required, contact an Authorized Service Center.

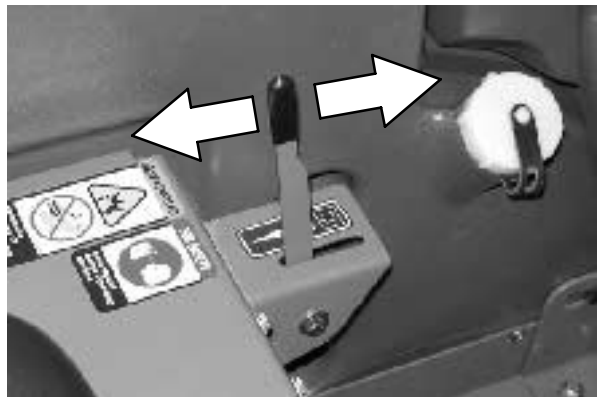

OPERATION

SCRUBBING SWITCH

The scrubbing switch controls the scrub head, scrub brushes, squeegee, and vacuum fan. The scrubbing switch is also used to set the scrub brush pressure.

Start scrubbing: Press the scrubbing switch. The indicator light will illuminate, the squeegee will lower, and the vacuum fan will start. The scrubbing system and solution flow will start when the directional pedal is pressed and the machine begins to move forward.

Stop scrubbing: Press the scrubbing switch. The pressure indicator light will go out. The scrub brushes stop, the scrub head will raise, and the solution flow will stop. After a short delay, the rear squeegee will automatically raise. After another delay, the vacuum will stop.

The brush down pressure indicators display the pressure selection. The brush pressure switch has four positions. Brush pressure increases as the indicator light moves to the right across the display. Travel speed and floor conditions will affect the scrubbing performance. Under normal conditions, the brush pressure should be set in the one of the minimum settings. Set the brush pressure in one of the maximum settings to scrub a heavily soiled floor.

Change brush pressure: Press and hold the scrubbing switch. The pressure indicator light will cycle through the four brush pressure settings. When the switch is pressed and held, the brush pressure will increase until it reaches the maximum setting. The pressure will then return to the minimum setting. Release the scrubbing switch when the desired setting is indicated on the display.

NOTE: When the machine power is turned off, the brush pressure will remain in the last setting used.

NOTE: The scrub switch also controls the FaST/ec-H2O system (option) when the FaST/ec-H2O system is enabled with the FaST/ec-H2O switch.



SQUEEGEE SWITCH

The squeegee switch controls the rear squeegee and vacuum fan.

Lower squeegee and turn vacuum fan on: Press the switch. The indicator light will illuminate when the squeegee is lowered.

Raise squeegee and turn vacuum fan off: Press the switch. The indicator light will go out when the squeegee is raised.

**ES SWITCH (OPTION)**

The ES (Extended Scrub) switch turns the solution recycling system on and off.

On: Press the switch.

Off: Press the switch.

NOTE: If the machine is powered off while in the ES mode, it will remain in the ES mode when the machine is powered on.

**FaST SWITCH (OPTION)**

The FaST switch enables the FaST (Foam Scrubbing Technology) system. When the FaST system is enabled, it is turned on and off with the scrub switch.

On: Press the *FaST switch*. The indicator light above the switch will illuminate.

Off: Press the *FaST switch*. The indicator light above the switch will turn off.

NOTE: The FaST system will not start until the directional pedal is pressed.

NOTE: To use the machine for conventional scrubbing, disable the FaST system by turning the FaST switch off.

NOTE: Do not use the FaST system when there are conventional cleaning detergents in the solution tank. Drain, rinse, and refill the solution tank with clear cool water before operating the FaST system. Conventional cleaning detergents may cause a FaST system failure.



OPERATION

ec-H2O SWITCH (OPTION)

The *ec-H2O* switch (option) enables the *ec-H2O* (electrically converted water) system. When the *ec-H2O* system is enabled, it is turned on and off with the scrub switch.

On: Press the *ec-H2O* switch. The indicator light above the switch will illuminate.

Off: Press the *ec-H2O* switch. The indicator light above the switch will turn off.

NOTE: Disable the ec-H2O system before using the machine for conventional scrubbing.

NOTE: The ec-H2O system will not start until the machine starts scrubbing.

NOTE: Do not enable the ec-H2O system with conventional cleaning detergents in the solution tank. Drain, raise and refill the solution tank with clear cool water only before operating the ec-H2O system. Conventional cleaning detergents/restorers may cause failure to the ec-H2O solution system.



RECOVERY TANK FULL INDICATOR

The recovery tank full indicator light will illuminate when the recovery tank is full.

NOTE: When the indicator illuminates, all scrubbing functions will shut off automatically.



BATTERY DISCHARGE INDICATOR

The battery discharge indicator displays the charge level of the batteries while the machine is operating.

When the batteries are fully charged, all four indicator lights are lit. As the batteries discharge, the indicator lights will go out from right to left. The batteries should be recharged when the indicator on the left flashes. *When the indicator flashes, all scrubbing functions will shut off automatically.* Drive the machine to the battery charging area and charge the batteries immediately after the battery discharge indicator begins to flash.

NOTE: The reading on the battery discharge indicator may not be accurate when the machine is first powered on. Operate the machine for a few minutes before reading the charge level of the batteries.

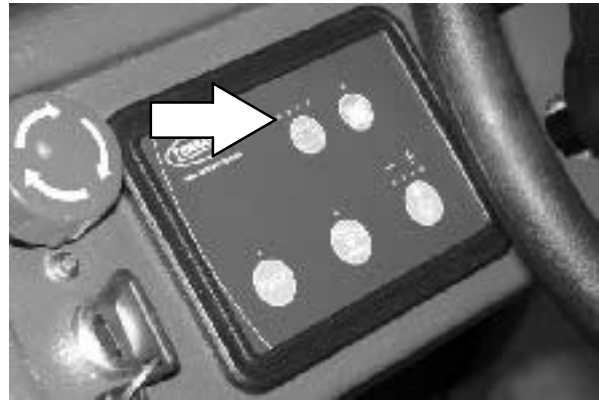

OPERATION

PRE-SWEEP SWITCH (OPTION)

The Pre-Sweep switch turns the Pre-Sweep option on and off.

On: Press the top of the switch. The Pre-Sweep assembly will lower. The indicator light will illuminate and the Pre-Sweep assembly will begin sweeping when the machine propels forward.

Off: Press the bottom of the switch. The indicator light will turn off. The Pre-Sweep assembly will stop sweeping and raise up to the off position.

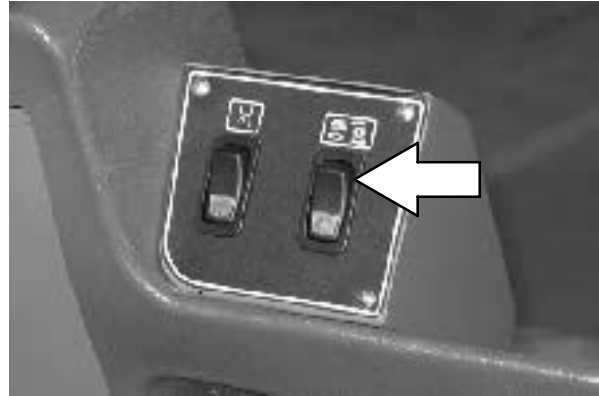

DUST CONTROL SWITCH (OPTION)

The dust control switch turns the dust control option on and off.

On: Press the top of the switch. The indicator light will illuminate and the dust control system will start spraying when the machine propels forward. The water will only spray for five seconds every two minutes.

NOTE: The dust control system will only operate if the Pre-Sweep option is on.

Off: Press the bottom of the switch. The indicator light will turn off. The dust control system will stop spraying.

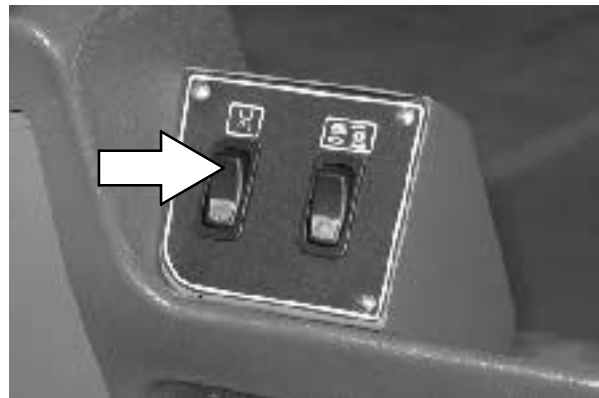

SIDE BRUSH PEDALS (OPTION)

The side brush pedals raise and lower the side brush (option).

Lower brush: Press the lower pedal with the toe of your foot to disengage the pedal lock. Release the pedal to lower the side brush to the floor and begin sweeping.

Raise brush: Press the top pedal all the way down with the toe of your foot. The side brush will raise to the off position and stop sweeping. Release the pedal and the pedal will lock automatically.

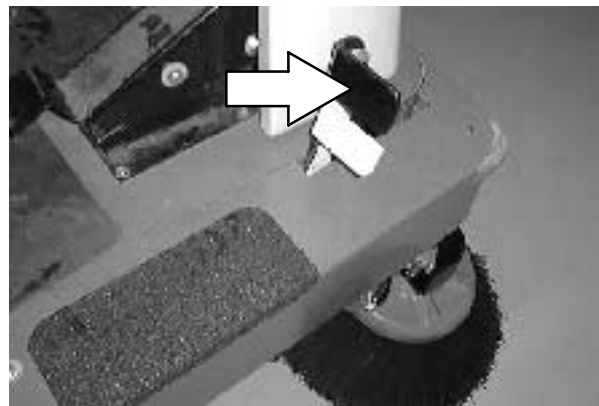

CIRCUIT BREAKERS

Circuit breakers are resettable electrical circuit protection devices designed to stop the flow of current in the event of a circuit overload. Once a circuit breaker is tripped, reset it manually by pressing the reset button after the breaker has cooled down.

NOTE: If the scrub system stops and the 4 brush indicator lights blink, ~~CB14~~ or ~~CB15~~ may need to be reset.
CB13 CB14



Circuit breaker 10 is located inside the Pre-Sweep assembly (option).

If the overload that caused the circuit breaker to trip is still present, the circuit breaker will continue to stop current flow until the problem is corrected.

The chart below shows the circuit breakers and the electrical components they protect.

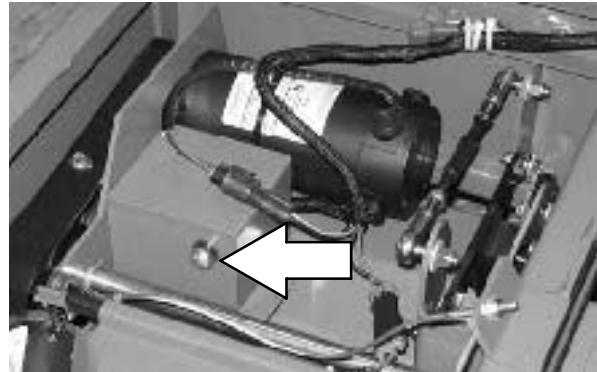

| Machines serial numbers 000000-015999 | | | Machines serial numbers 016000- | | |
|---------------------------------------|--------|--|--|--------|--|
| Circuit Breaker | Rating | Circuit Protected | Circuit Breaker | Rating | Circuit Protected |
| CB1 | 10 A | Machine power | CB1 | 2.5 A | Machine power |
| CB2 | 10 A | Start | CB2 | 2.5 A | Start |
| CB3 | 15 A | Head lights | CB3 | 10 A | Head lights / Warning lights |
| CB4 | 10 A | Power wand / Side brush (option) | CB4 | 10 A | Power wand / Side brush (option) |
| CB5 | 10 A | Horn | CB5 | 2.5 A | Horn |
| CB6 | 15 A | Instrument panel/FaST or ES pump (option) | CB6 | 15 A | Instrument panel and loads |
| CB7 | 20 A | Vacuum Fan (50 A - If heavy duty vacuum fan) | CB7 | 2.5 A | ec-H20 controller (option) |
| CB8 | 25 A | RH Scrub brush motor | CB8 | 2.5 A | ec-H20 pump (option) |
| CB9 | 25 A | LH Scrub brush motor | CB9 | 10 A | FaST (option) |
| CB10 | 25 A | Pre-Sweep (option) | CB10 | 25 A | Pre-Sweep (option) |
| CB11 | - | Not Used | CB11 | 2.5 A | Taillights |
| CB12 | 10 A | Pre-Sweep Side brush motors (option) | CB12 | - | Not Used |
| | | | CB13 CB15 | 25 A | Vacuum fan (50 A - If heavy duty vacuum fan) |
| | | | CB14 | 30 A | RH Scrub brush motor |
| | | | CB15 | 30 A | LH Scrub brush motor |

CB13

OPERATION

FUSE

The fuse is a one-time protection device designed to stop the flow of current in the event of a circuit overload.

NOTE: Always replace the fuse with a fuse of the same amperage.

The fuse is located behind the operator console. Access the fuse by lowering the operator console.

| Fuse | Rating | Circuit Protected |
|------|--------|-------------------|
| FU-1 | 80 A | Propelling |



STEERING WHEEL

The steering wheel controls the machine's direction of travel.

Left: Turn the steering wheel to the left.

Right: Turn the steering wheel to the right.



SQUEEGEE WHEEL CAMS

The squeegee wheel cams adjust the squeegee deflection along the entire length of the squeegee. There are wheel cams at either end of the squeegee.

Increase deflection: Turn the cams counter-clockwise.

Decrease deflection: Turn the cams clockwise.

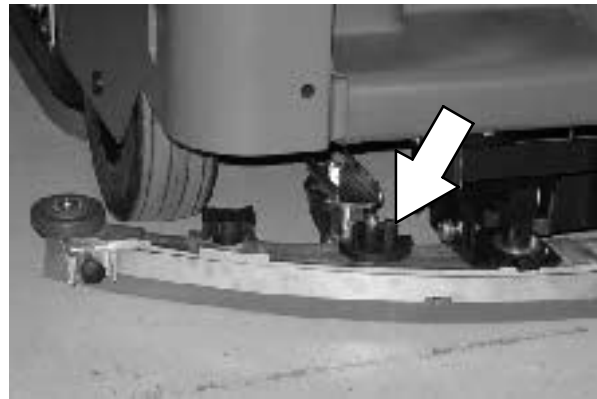

SQUEEGEE LEVELING KNOB

The squeegee leveling knob adjusts the deflection at the ends of the squeegee.

The squeegee leveling knob is located directly behind the squeegee suction hose. **DO NOT** disconnect the suction hose from the squeegee frame when leveling the squeegee.

Increase end deflection: Turn the squeegee leveling knob counter-clockwise to increase the deflection at the end of the squeegees.

Decrease end deflection: Turn the squeegee leveling knob clockwise to decrease the deflection at the end of the squeegees.

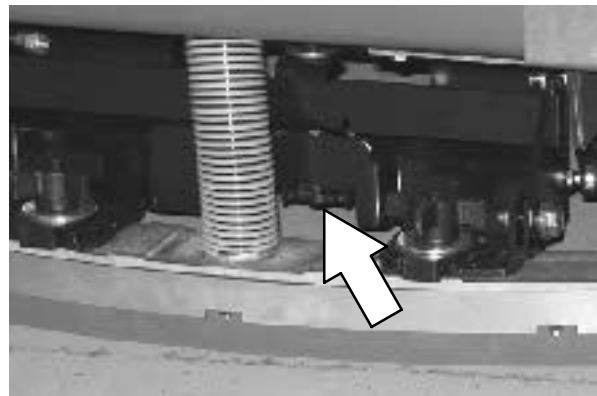

SIDE SQUEEGEE DOWN PRESSURE CONTROLS

The side squeegee down pressure controls increase or decrease the amount of the side squeegee pressure to the floor.

Increase down pressure: Remove spring from pin and move the pin toward the rear of the machine into a new setting. Re-attach spring to pin.

Decrease down pressure: Remove spring from pin and move the pin toward the front of the machine into a new setting. Re-attach spring to pin.

NOTE: Adjust the side squeegee down pressure controls equally.



HOW THE MACHINE WORKS

The following machine components work together to effectively clean dirty floors: Pre-Sweep (option) or side brush (option), solution tank, scrub brushes, squeegee, vacuum fan, and recovery tank.

The Pre-Sweep (option) and the side brush (option) sweep up light debris in the path of the machine.

Water and detergent from the solution tank flow to the floor through a solution valve. The brushes use the detergent and water solution to scrub the floor clean. As the machine propels forward, the squeegee wipes the dirty solution from the floor. The suction created by the vacuum fan then draws the dirty solution from the squeegee into the recovery tank.

The directional pedal controls the speed and direction of the machine. The brake pedal slows and stops the machine.

When using the ES mode (option), the dirty solution in the recovery tank is filtered and returned to the solution tank to be reused for extended scrubbing.

The two available scrub head types use *disk* or *cylindrical* brushes.

NOTE: The amount and type of soilage play an important role in determining the type of brushes to be used. For specific recommendations, contact your Tennant representative.

BRUSH AND PAD INFORMATION

For best results, use the correct brush type for the cleaning application.

NOTE: The amount and type of soilage play an important role in determining the type of brushes to use. Contact a Tennant representative for specific recommendations.

Pre-sweep-Polypropylene 6-double row Brush - Recommended for general sweeping applications.

Polypropylene Side Brush - Recommended for general sweeping of light to medium debris.

Non-scuff polypropylene scrub brush – This brush uses a softer, general purpose polypropylene bristle to lift lightly compacted soilage without scuffing high-gloss coated floors.

Nylon scrub brush – Recommended for scrubbing coated floors. Cleans without scuffing.

Super abrasive bristle scrub brush – Nylon fiber impregnated with abrasive grit to remove stains and soilage. Strong action on any surface, performing well on buildup, grease, or tire marks.

Heavy duty stripping pad – This black pad is for stripping floors. Cuts through old heavy finishes easier, to prepare the floor for re-coating.

Stripping pad – This brown pad is for stripping floors. Quickly and easily cuts through old finish to prepare the floor for recoating.

Scrubbing pad – This blue pad is for scrubbing floors. Removes dirt, spills, and scuffs. Leaves a clean surface ready for re-coating.

Buffing pad – This red pad is for buffing floors. Quickly cleans and removes scuff marks while polishing the floor to a high gloss.

Polishing pad – This white pad is for polishing floors. Maintains a high gloss. Use for buffing very soft finishes and lower traffic areas, and polishing soft waxes on wood floors.

Cylindrical polypropylene scrub brush – This cylindrical brush uses a softer, general purpose polypropylene bristle to lift lightly compacted soilage without scuffing high-gloss coated floors.

Cylindrical nylon scrub brush – This cylindrical brush is recommended for scrubbing coated floors. Cleans without scuffing.

Cylindrical super abrasive bristle scrub brush
– Nylon fiber impregnated with abrasive grit to remove stains and soilage. Strong action on any surface, performing well on buildup, grease, or tire marks.

OPERATION

FaST SCRUBBING SYSTEM

Unlike conventional scrubbing, the FaST (Foam Scrubbing Technology) system operates by injecting the FaST PAK concentrate agent into the system with a small amount of water and compressed air. This mixture creates a large volume of expanded wet foam.

The expanded foam mixture is then dispersed onto the floor while the machine is scrubbing. When the squeegee picks up the mixture, the patented foaming agent has collapsed and is recovered into the recovery tank.

The FaST system can be used with all double scrubbing and heavy duty scrubbing applications.

Using the FaST system can increase productivity by 30% by reducing your dump/fill cycle. It will also reduce chemical usage and storage space. One FaST PAK of concentrated agent can scrub up to 1 million sq. ft.

NOTE: Do not use the FaST system when there are conventional cleaning detergents in the solution tank. Drain, rinse, and refill the solution tank with clear cool water before operating the FaST system. Conventional cleaning detergents may cause a FaST system failure.

NOTE: Storage or transporting machines equipped with FaST in freezing temperatures requires special procedures. Check with a TENNANT representative for advice.

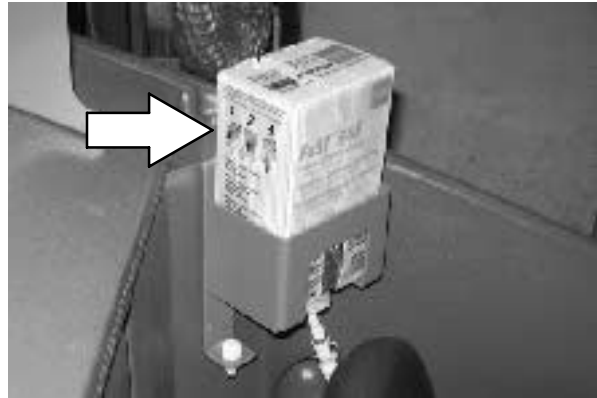

FaST
Foam Scrubbing Technology®

The Safe Scrubbing Alternative®

ec-H2O SYSTEM (OPTION)

The *ec-H2O* (electrically converted water) system operates by producing electrically converted water for cleaning.

Normal water passes through a module where it is oxygenated and charged with an electric current. The electrically converted water changes into a blended acidic and alkaline solution forming a neutral pH cleaner. The converted water attacks the dirt, breaks it into smaller particles, and pulls it off the floor surface allowing the machine to easily scrub away the suspended soil. The converted water then returns to normal water in the recovery tank.

The *ec-H2O* system can be used with all double scrubbing applications.

NOTE: Do not enable the ec-H2O system with conventional cleaning detergents in the solution tank. Drain, raise and refill the solution tank with clear cool water only before operating the ec-H2O system. Conventional cleaning detergents/restorers may cause failure to the ec-H2O solution system.

NOTE: Storage or transporting machines equipped with ec-H2O in freezing temperatures requires special procedures. Follow the freeze protection procedure located in the STORAGE INFORMATION section.



ec  **H2O**™
ELECTRICALLY CONVERTED WATER

PRE-OPERATION CHECKLIST

Perform the following steps before operating the machine:

- Check the brakes and steering for proper operation.
- Check the operating lights.
- Check for wire, string, or twine wrapped around the main scrub brushes.
- Machines equipped with cylindrical brushes: Confirm the debris tray is empty and clean.
- Check right side squeegee for wear and damage.
- Machines equipped with Pre-Sweep option: Check for wire, string, or twine wrapped around the scrub brush.
- Machines equipped with Pre-Sweep option: Fill the dust control water reservoir.
- Machines equipped with Pre-Sweep option: Confirm debris trough is empty.
- Check the left side squeegee for wear and damage.
- Check the rear squeegees for wear and damage.
- Check the recovery tank cover seals for wear or damage.
- Confirm the vacuum fan inlet filter is clean.
- Machines equipped with ES option: Ensure ES filter at bottom of recovery tank is clean.
- FaST Scrubbing: Check the FaST PAK concentrate agent level, replace carton as needed. See the INSTALLING THE FaST PAK AGENT section of the manual.
- For FaST or *ec-H2O* Scrubbing: Confirm all conventional cleaning agents/restorers are drained and rinsed from the solution tank.
- For FaST or *ec-H2O* Scrubbing: Confirm the solution tank is filled with **clear cool water only**.
- Check maintenance records to determine maintenance requirements.

INSTALLING FaST PAK AGENT

NOTE: Machine must be equipped with the FaST system.

1. Remove the perforated knock-outs from the FaST PAK Floor Cleaning Concentrate carton. Do not remove the bag from the carton. Pull out the bag's hose connector on the bottom of the bag and remove the hose cap from the connector.

NOTE: The FaST PAK Floor Cleaning Concentrate is specially designed for use with the FaST system scrubbing application. NEVER use a substitute, machine damage will result.

FOR SAFETY: When using machine, always follow the handling instructions on chemical container.

2. Empty the solution tank. See DRAINING AND CLEANING THE TANKS section of the manual.

NOTE: When scrubbing with the FaST system, use clean water only. Do not add cleaning agents in the solution tank. Conventional cleaning agents/restorers may cause failure to the FaST solution system.

3. Place the FaST PAK carton in the carton holder located next to the seat. Connect the supply hose to the FaST PAK bag.

NOTE: If any dried concentrate is visible on the supply hose connector or the on the FaST PAK connector, soak and clean with warm water.

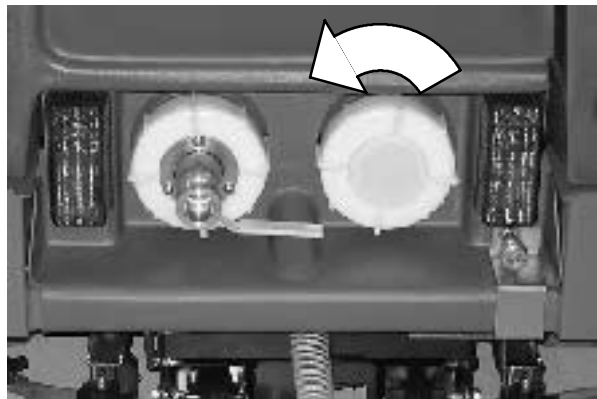

OPERATION

4. Make sure to connect the supply hose onto the hose storing plug when the supply hose is not connected to the FaST PAK. This will prevent the FaST solution system from drying out and clogging up the hose.
5. The FaST solution system must be primed for first time use only. To prime system, make sure the solution tank is empty, and operate the machine in the FaST Scrub Mode for 7-10 minutes.
6. When replacing an empty FaST PAK carton, allow the new FaST PAK detergent to gravity feed into the system for several minutes prior to operating the FaST system. If the detergent does not flow out of the FaST PAK, simply squeeze and release the hose several times. If the previous FaST PAK was run dry, it may take up to 7-10 minutes of operation to remove any air pockets in the system before you achieve maximum foaming.

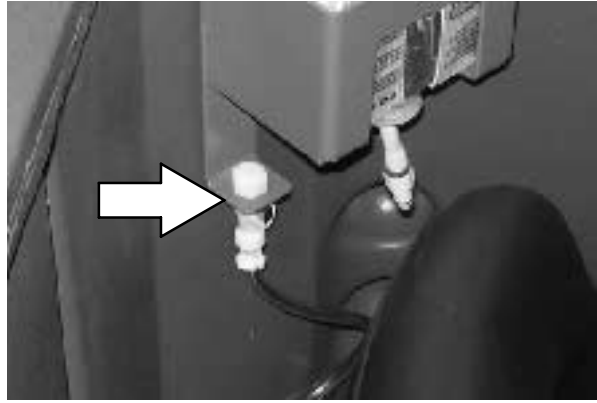

STARTING THE MACHINE

1. You must be in the operator's seat with the directional pedal in neutral.

FOR SAFETY: When starting machine, keep directional pedal in neutral.

2. Turn the machine power on.

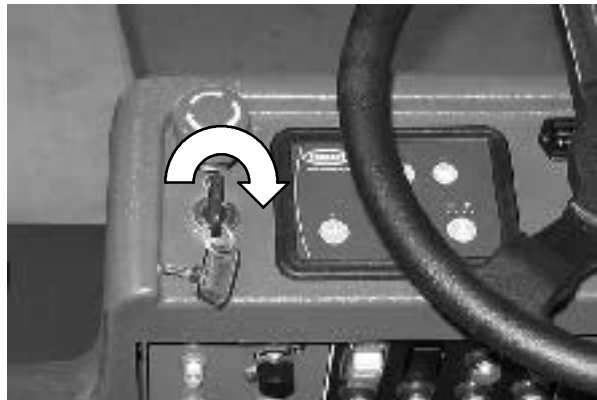

3. Drive the machine to the area to be cleaned.

NOTE: The machine will not travel unless the operator is sitting in the operator's seat.

FILLING THE TANKS

1. Turn the machine power on.
2. Drive the machine to the tank filling site.
3. Turn the machine power off.

FOR SAFETY: Before leaving or servicing machine, stop on level surface, turn off machine, and remove key.

4. **CONVENTIONAL SCRUBBING:** Lift the tank cover. Measure and pour in the correct amount of detergent. Fill the rest of the solution tank to the top with water.

NOTE: Floor conditions, water condition, amount of soilage, type of soilage, and brush pressure all play an important role in determining the type and concentration of detergent to be used. For specific recommendations, contact your Tennant representative.



WARNING: Flammable materials can cause an explosion or fire. Do not use flammable materials in tank(s).

FOR SAFETY: When using machine, follow mixing and handling instructions on chemical containers.

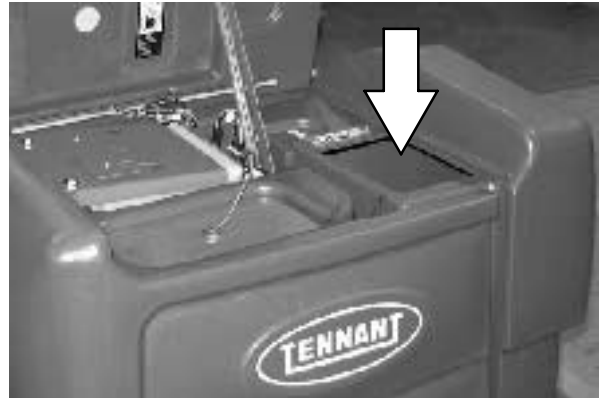

OPERATION

- ES mode (option): Remove the seal plate and fill the recovery tank with water and detergent up to the lower sensor float to extend scrub time. Reinstall the seal plate. Make sure the ES system is on.



WARNING: Flammable materials can cause an explosion or fire. Do not use flammable materials in tank(s).

FOR SAFETY: When using machine, follow mixing and handling instructions on chemical containers.



*NOTE: If you **DO NOT** want to use the ES mode (option), **DO NOT** put water in the recovery tank and make sure the ES system is off.*

- FaST or ec-H₂O SCRUBBING: Open the solution tank cover and fill the solution tank with clear cool water only.

*NOTE: When cleaning using the FaST or ec-H₂O option, **USE CLEAR COOL WATER ONLY. DO NOT** add cleaning agents in solution tank. Conventional cleaning agents/restorers may cause failure to the system.*



- Lower the tank cover.

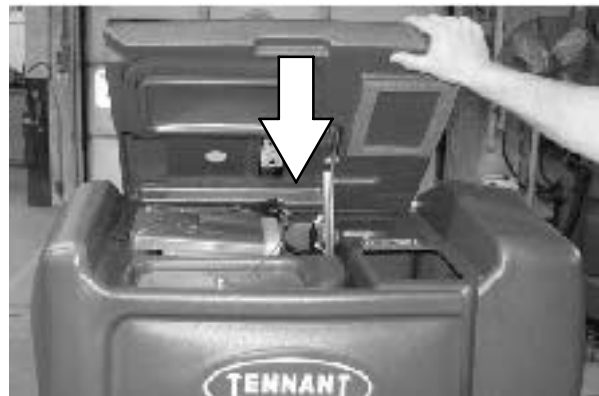

SCRUBBING

- Pick up oversized debris before scrubbing. Pick up pieces of wire, string, twine, etc., which could become wrapped around the scrub brush.
- Plan the scrubbing in advance. Try to arrange long runs with minimum stopping and starting. Do an entire floor or section at one time.
- Try to scrub as straight a path as possible. Avoid bumping into posts or scraping the sides of the machine. When scrubbing dead end aisles, start at the closed end of the aisle and scrub your way out. Overlap the scrub paths by 50 - 75 mm (2 - 3 in).
- If the machine is scrubbing poorly, stop scrubbing and refer to the *MACHINE TROUBLESHOOTING* section of this manual. Basic troubleshooting procedures are also covered in the Use and Care Guide located near the operator seat.



07218

1. Start the machine.

2. Drive the machine to the area to be scrubbed.

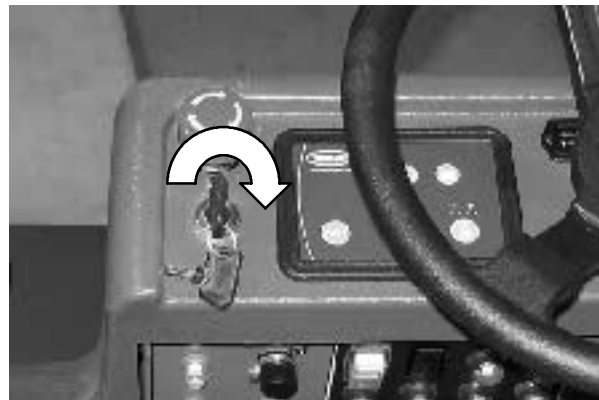

3. Pre-sweep machines: Press the top of the Pre-sweep switch to lower the Pre-sweep assembly.

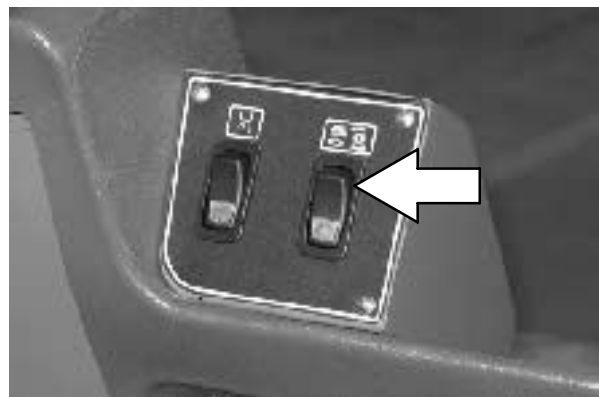

OPERATION

4. Pre-sweep machines: Press the top of the dust control switch to start the dust control system.

NOTE: The dust control system will only operate if the Pre-Sweep option is on.

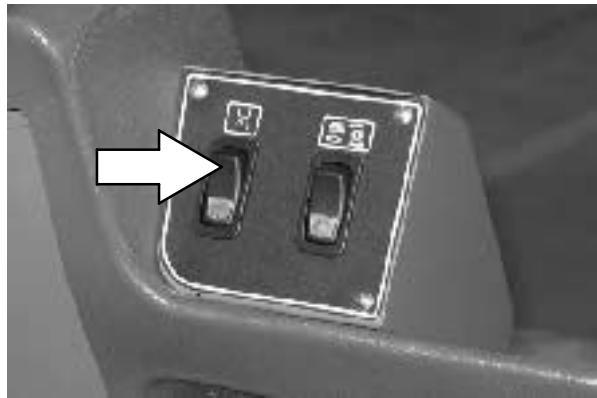

5. Press the *ES* switch (option) if extended scrubbing is necessary.



6. FaST SCRUBBING: Press the *FaST* switch to enable the FaST system. See the FaST SWITCH section of the manual.



ec-H2O SCRUBBING: Press the *ec-H2O* switch to enable the *ec-H2O* system. See the *ec-H2O* SWITCH section of the manual.

NOTE: The ec-H2O system indicator light will not turn on until the machine starts scrubbing.



ec-H2O Model: If an alarm sounds and the ec-H2O system indicator light begins to blink red, the ec-H2O module must be flushed to resume ec-H2O operation (See ec-H2O MODULE FLUSH PROCEDURE).

NOTE: When the alarm sounds and the light blinks red, the machine will bypass the ec-H2O system. To continue scrubbing, turn the ec-H2O switch off and change over to conventional scrubbing.

| ec-H2O SYSTEM INDICATOR LIGHT CODE | CONDITION |
|---|------------------------|
| Solid green | Normal operation |
| Blinking red | Flush ec-H2O module |
| Solid red | Contact Service Center |

7. Press the scrubbing switch.



OPERATION

8. CONVENTIONAL SCRUBBING: Adjust the solution flow as needed.

NOTE: When using the FaST or ec-H2O system (option), the solution flow lever is nonfunctional. The FaST and ec-H2O system flow rates are pre-set. The ec-H2O module has optional flow rate settings. If solution flow adjustments are required, contact an Authorized Service Center.

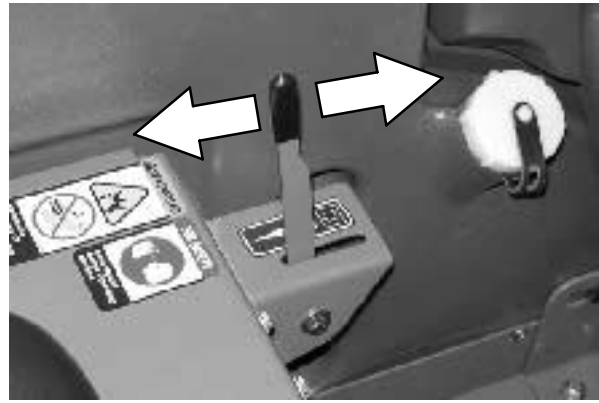

9. Press the lower side brush pedal to lower the side brush (option).

10. Drive the machine forward and scrub as required.



WARNING: Flammable materials or reactive metals can cause an explosion or fire. Do not pickup.

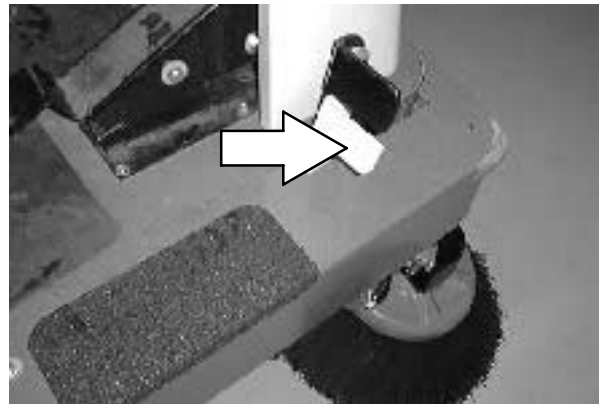

DOUBLE SCRUBBING

Double scrubbing is the process of making two or more scrubbing passes over a heavily soiled area. The first scrubbing pass is made with rear squeegee up to allow the solution to soak into the floor.

Double scrubbing can be performed using the FaST SCRUBBING SYSTEM (option), ec-H₂O SCRUBBING SYSTEM (option) or CONVENTIONAL SCRUBBING methods.

Pre-sweep and side brush (option) machines: Leave the Pre-sweep and side brush (options) in the raised position while double scrubbing.

Press the scrubbing switch to start the normal scrubbing operations.

Press the squeegee switch to raise the rear squeegee and turn off the vacuum system.

Make a scrubbing pass over the heavily soiled area with the rear squeegee raised. The solution dispensed on the first scrubbing pass will remain on the floor and break down heavy soilage. Allow the solution to remain on the floor for 15 to 20 minutes. Make a second scrubbing pass with the squeegee down while continuing to dispense solution to the floor.

NOTE: When using the FaST or ec-H₂O system (option), the solution flow lever is nonfunctional. The FaST and ec-H₂O system flow rates are pre-set. The ec-H₂O module has optional flow rate settings. If solution flow adjustments are required, contact an Authorized Service Center.

FOR SAFETY: When using machine, go slow on inclines and slippery surfaces.



OPERATION

STOP SCRUBBING

1. Press the scrubbing switch to stop the scrubbing operations while the machine is still in motion. The squeegee will briefly remain lowered to the floor to pick up the water in the scrub head.



2. Pre-sweep machines: Press the bottom of the dust control switch to stop the dust control (option).

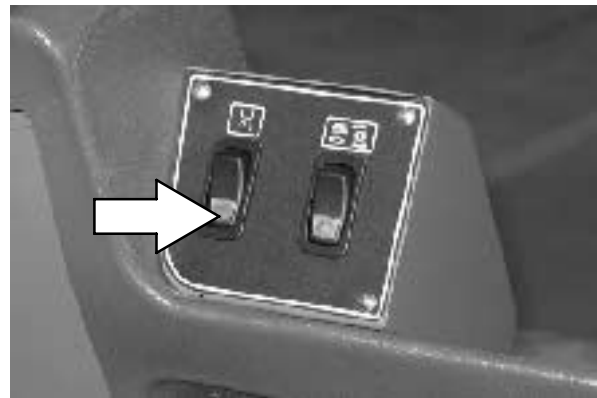

3. Pre-sweep machines: Press the bottom of the Pre-sweep switch to stop the Pre-sweep assembly.

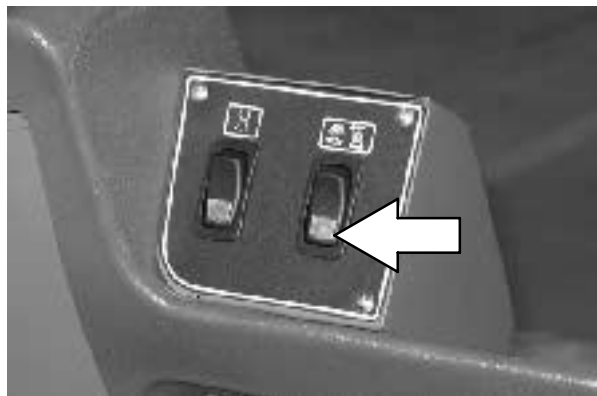

4. Press the top side brush pedal to raise the side brush (option).

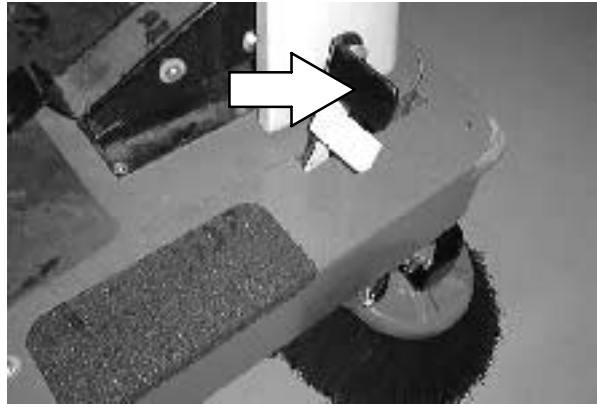

5. When the squeegee raises, take your foot off the directional pedal.

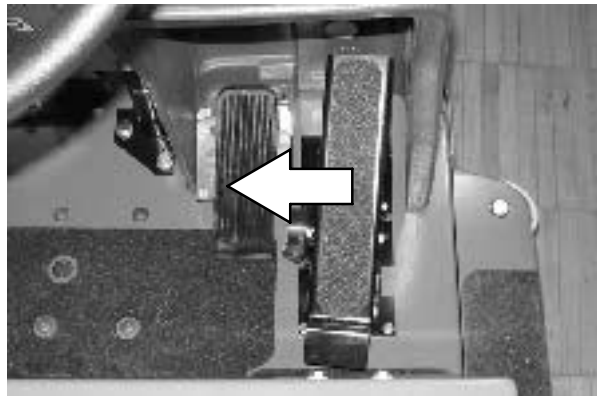

6. Press the brake to stop the machine.

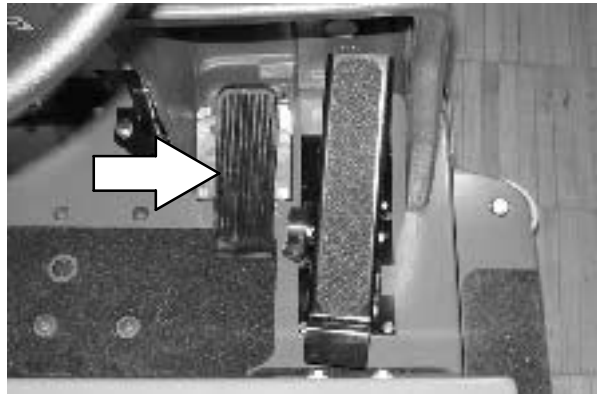

DRAINING AND CLEANING THE TANKS

When you are finished scrubbing, or when the recovery tank full indicator illuminates, the recovery tank should be drained and cleaned. The solution tank can then be filled again for additional scrubbing if necessary.

If you used the machine in ES mode (option), the solution tank should also be drained and cleaned when you drain and clean the recovery tank.

Tank draining and cleaning procedures are covered in the Use and Care Guide located near the operator seat.

1. Stop scrubbing.
2. Drive the machine next to a floor drain.
3. Turn the machine power off.

FOR SAFETY: Before leaving or servicing machine, stop on level surface, turn off machine, and remove key.

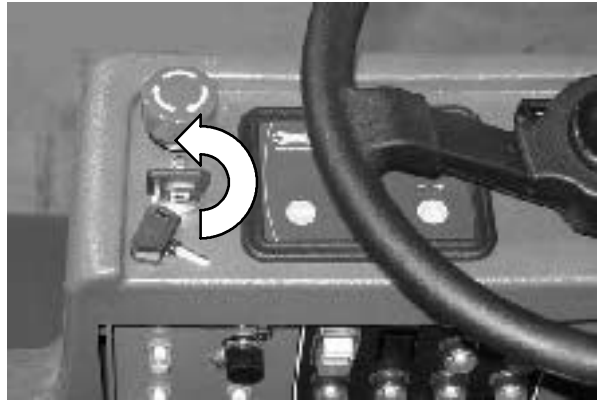

4. ES mode (option): Remove the cap to drain the solution tank.

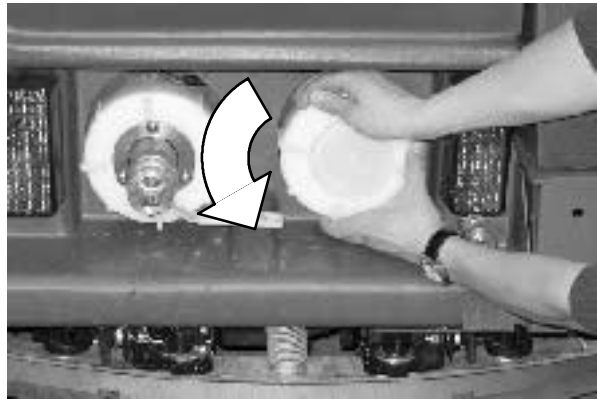

5. ES mode (option): Lift the tank cover and flush out the solution tank with clean water. Rinse the filter at the bottom of the solution tank and the sensor float near the top of the tank.

NOTE: DO NOT use steam to clean the tanks. Excessive heat can damage the tanks and components.



6. ES mode (option): After the solution tank has completely drained, reinstall the cap onto the solution tank drain opening.

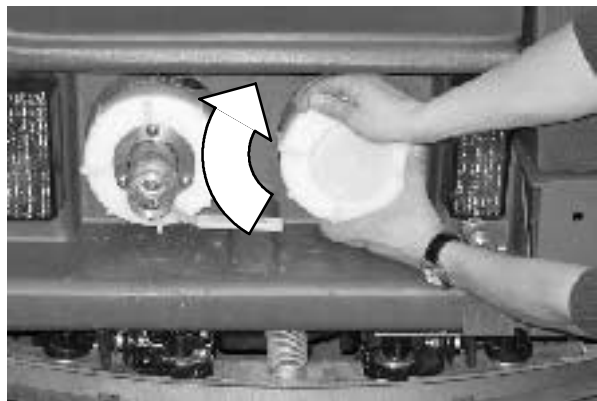

OPERATION

7. Access the recovery tank drain hose by loosening the retaining ring and then pulling the hose out.

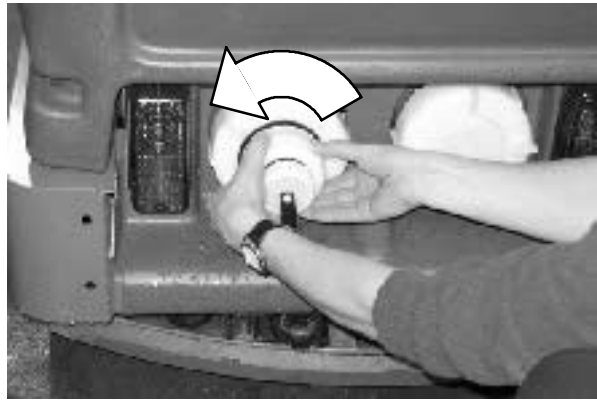

8. Remove the drain hose cap while holding the hose up, then slowly lower the drain hose to the floor drain.



9. Flush out the inside of the recovery tank with clean water.
10. ES mode (option): Flush out the recovery tank with clean water. Rinse the ES filter at the bottom, and the sensor floats near the top of the tank.

NOTE: ***DO NOT** use steam to clean the tanks. Excessive heat can damage the tanks and components.*



11. When heavy deposits of sand and debris collect on the bottom of the tank, flush out the recovery tank by placing a hose into the side clean-out port.



WARNING: Flammable materials can cause an explosion or fire. Do not use flammable materials in tank(s).

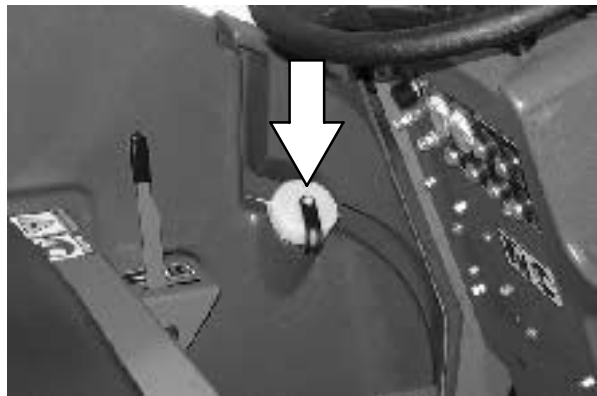

12. Check the vacuum fan inlet filter daily. Clean inlet filter with a damp cloth or hose when dirty. Allow filter to dry completely before replacing it into machine.



13. Lower the tank cover by raising it slightly, then push inward on the support arm.



14. Cylindrical scrub head: Remove the cotter pin that holds the side squeegee in place. Swing the squeegee away from the scrub head.

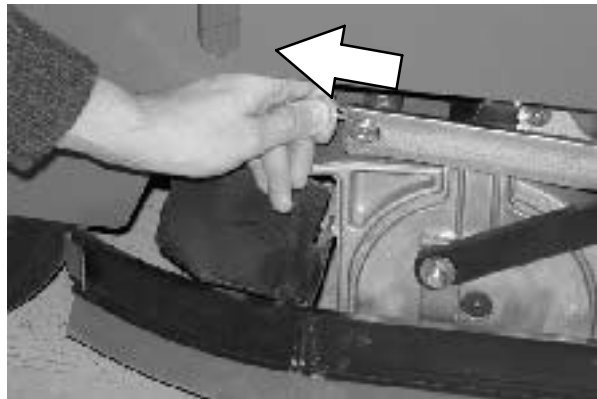

15. Cylindrical scrub head: Remove and clean the debris trough. Place the trough back in the scrub head when clean.

NOTE: The scrub head must be lowered approximately 25 mm (1 in) to remove debris trough.

NOTE: The debris trough can be removed from the right hand side of the machine only.

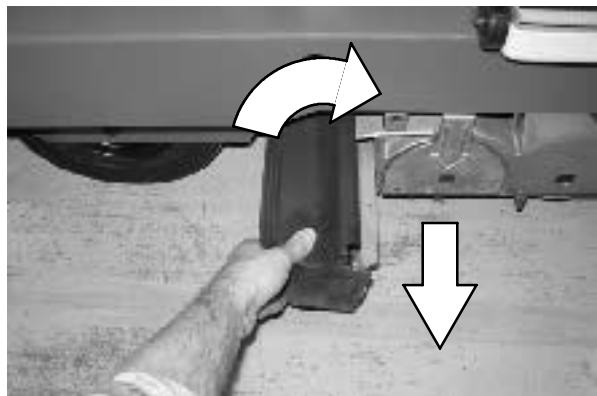

STOP THE MACHINE

1. Stop scrubbing. *See the STOP SCRUBBING section of the manual.*
2. Press the brake to stop the machine.

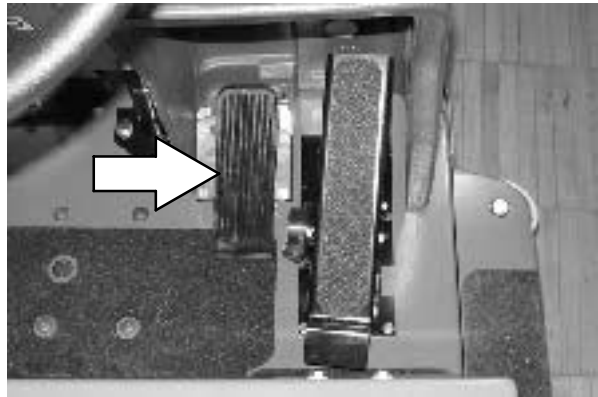

3. Turn the machine power off.

FOR SAFETY: Before leaving or servicing machine, stop on level surface, turn off machine, and remove key.

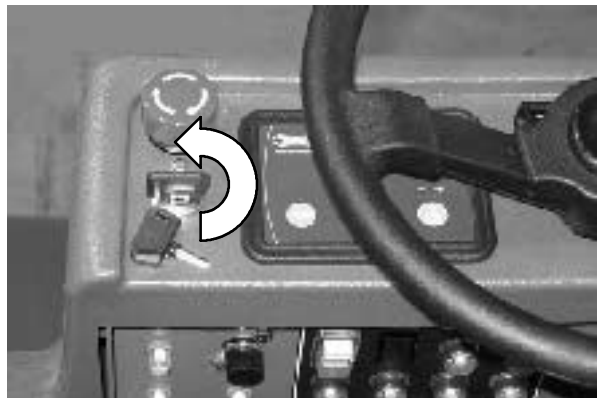

OPTIONS

SIDE BRUSH

The side brush (option) sweeps debris into the path of the main cylindrical brush.

 **WARNING: Flammable materials or reactive metals can cause an explosion or fire. Do not pickup.**

1. Turn the machine power on.
2. Press the scrub switch and begin scrubbing.



3. Press the lower side brush pedal to disengage the pedal lock. Release the pedal to lower the side brush (option) to the floor and begin sweeping.

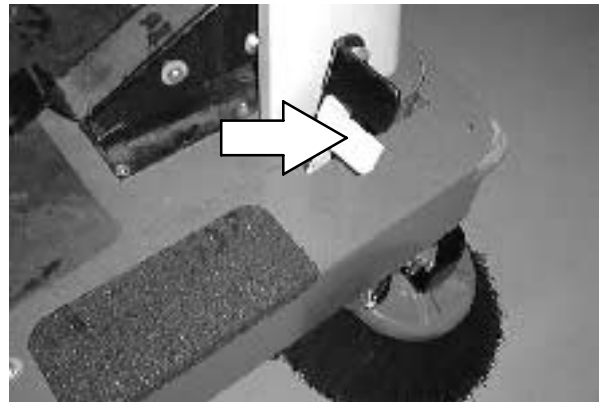

4. Press the top side brush pedal all the way down with the toe of your foot to raise the side brush, engage the pedal lock and stop sweeping.

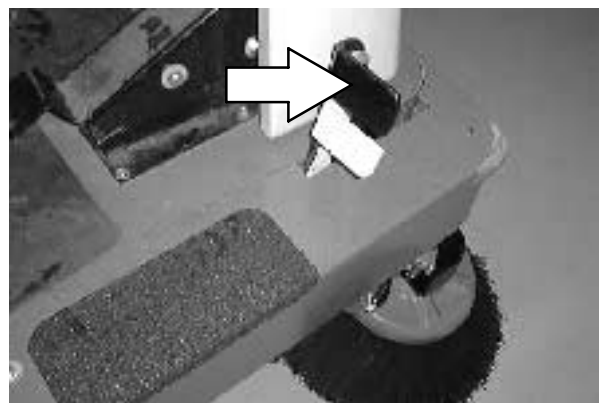

OPERATION

PRE-SWEEP ASSEMBLY

The Pre-Sweep assembly is mounted to the front of the machine and gives the machine the added ability to pick up debris. The assembly contains a main brush and side brush(es) which sweep debris into a debris hopper. Periodically empty the debris hopper as it fills with debris.

The Pre-Sweep assembly has a dust control system that sprays for five seconds, once every five minutes.

The machine may be operated with or without the Pre-Sweep assembly. Refer to PRE-SWEEP in the MAINTENANCE section for maintenance and adjustments.



WARNING: Flammable materials or reactive metals can cause an explosion or fire. Do not pickup.

1. Turn the machine power on.
2. Press the top of the Pre-Sweep switch to lower the Pre-Sweep assembly. The Pre-Sweep assembly will begin sweeping when the machine propels forward.

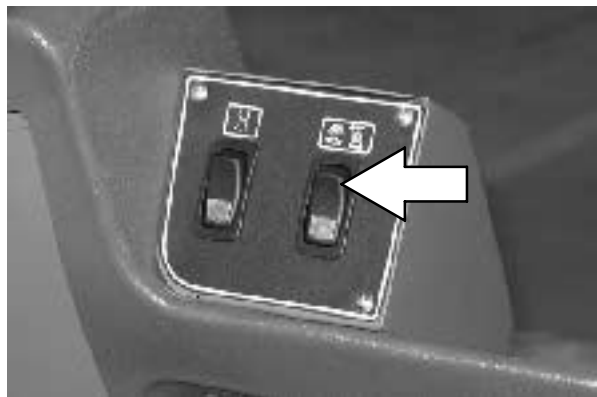

3. Press the top of the dust control switch to start the dust control system.

NOTE: The dust control system will only operate if the Pre-Sweep option is on.

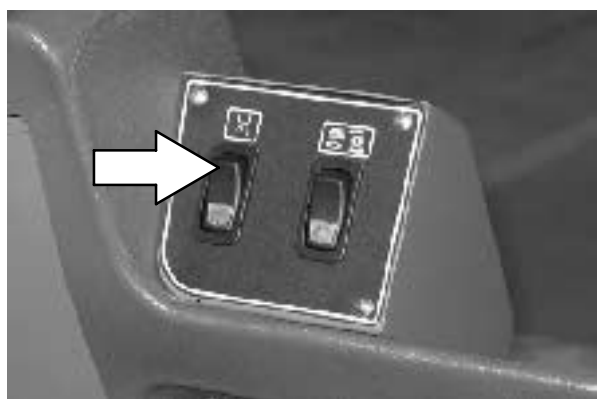

4. Press the bottom of the dust control switch to stop the dust control system.

NOTE: The dust control system will only operate if the Pre-Sweep option is on.

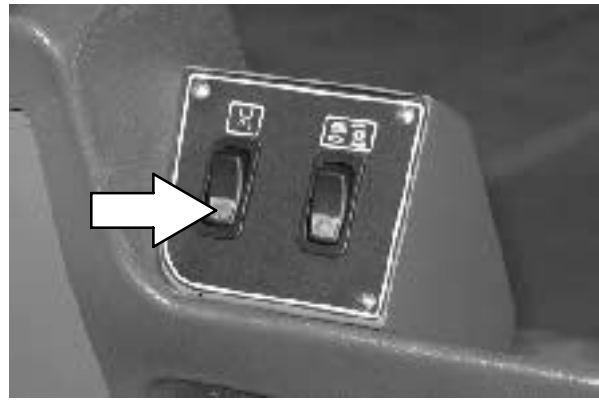

5. Press the bottom of the Pre-Sweep switch to raise the Pre-Sweep assembly and stop sweeping.

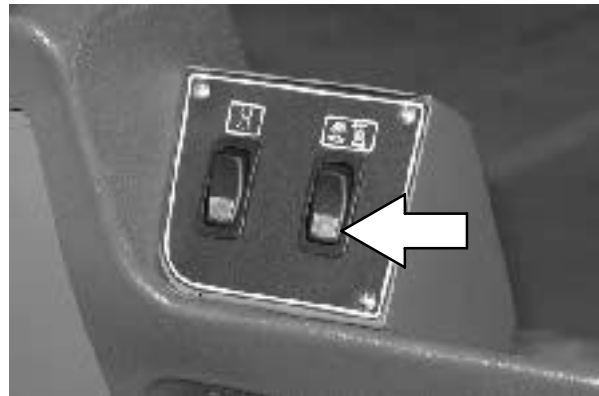

TO EMPTY THE PRE-SWEEP DEBRIS HOPPER

1. Turn the machine power on.
2. Press the top of the Pre-Sweep switch to lower the Pre-Sweep assembly.
3. Turn the machine power off.

FOR SAFETY: Before leaving or servicing machine, stop on level surface, turn off machine, and remove key.

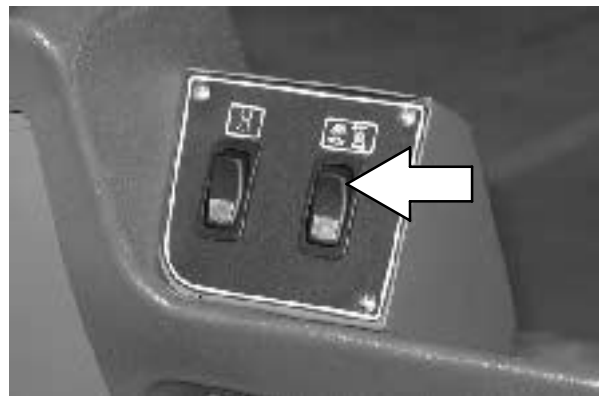

OPERATION

4. Remove the Pre-Sweep side brush arm cotter pins from each side brush arm.

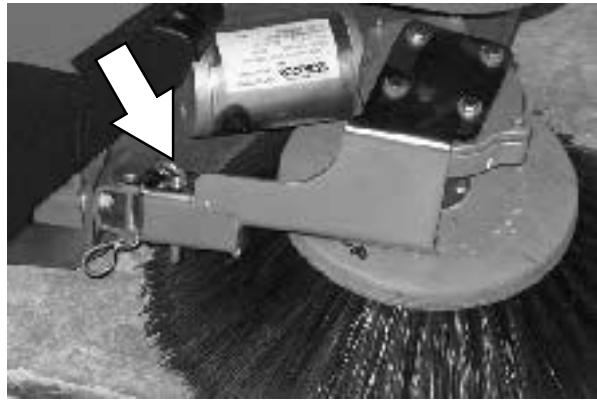

5. Pivot the side brush arms out away from the machine.



6. Lift the Pre-Sweep debris hopper and remove it from the Pre-Sweep assembly.

7. Empty the debris hopper. Replace the debris hopper in the Pre-Sweep assembly.



TO REMOVE THE PRE-SWEEP ASSEMBLY

1. Remove the Pre-Sweep debris hopper. Refer to the TO EMPTY THE PRE-SWEEP DEBRIS HOPPER section of the manual.

2. Position the Pre-Sweep assembly on the Pre-Sweep dolly or shipping pallet.

3. Turn the machine power off.

FOR SAFETY: Before leaving or servicing machine, stop on level surface, turn off machine, and remove key.

4. Disconnect the Pre-Sweep harness from the main harness.

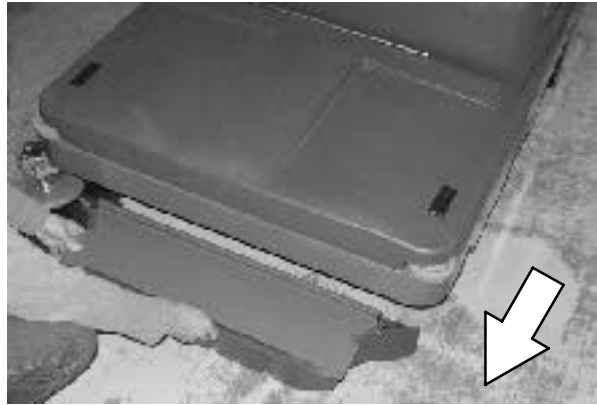

5. Open the front access cover and remove the hardware mounting the Pre-Sweep to the machine frame.

6. Move the machine away from the Pre-Sweep assembly.

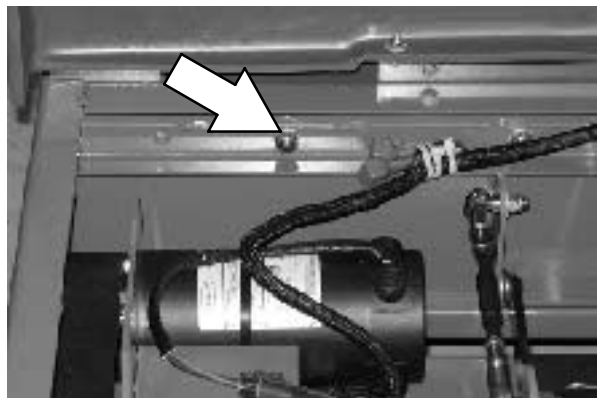

OPERATION

TO MOUNT THE PRE-SWEEP ASSEMBLY

1. Turn the machine power on.
2. Move the machine so the Pre-Sweep assembly is in front of the machine.
3. Turn the machine power off.

FOR SAFETY: Before leaving or servicing machine, stop on level surface, turn off machine, and remove key.

4. Set the Pre-Sweep assembly in place with the plate clamps. Shift the assembly right or left so the mounting holes line up in front of the machine.

5. Insert and tighten the mounting hardware.

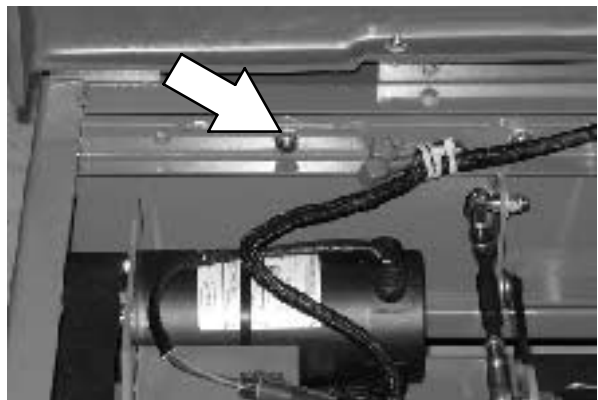
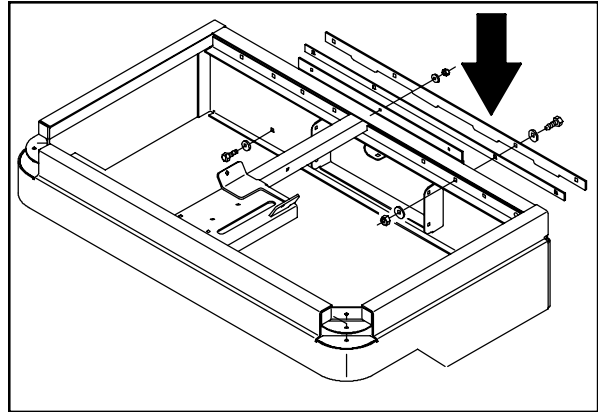
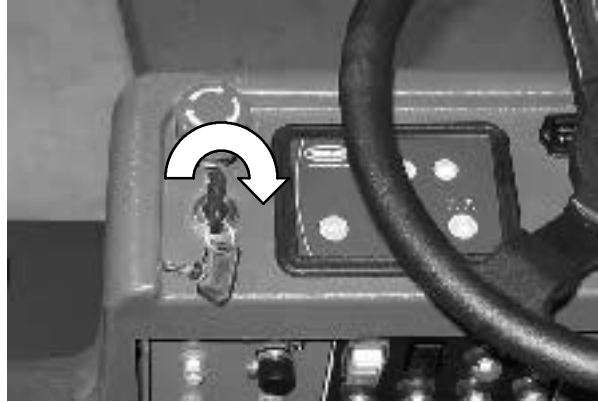

6. Connect the Pre-Sweep harness to the main harness.



7. Turn the machine power on. Check the Pre-Sweep assembly for proper operation.

8. Check the main brush and side brush pattern. Refer to the Pre-Sweep section in the MAINTENANCE section of the manual

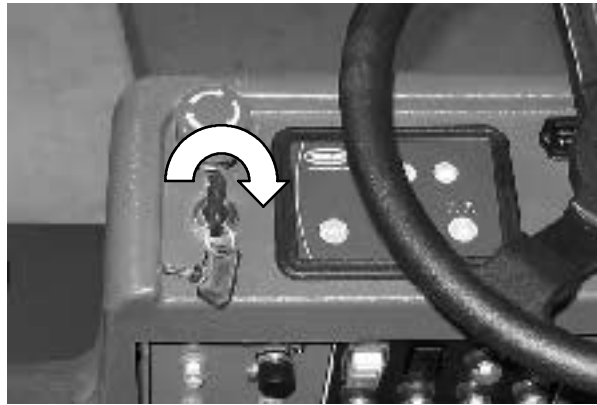

OPERATION

POWER WAND

The power wand uses the machine's vacuum and solution systems. The power wand is designed to scrub narrow or partially enclosed areas of the floor.



WARNING: Flammable materials or reactive metals can cause an explosion or fire. Do not pickup.

1. Press the squeegee switch. When the rear squeegee lowers all the way to the floor, turn the machine power off.

FOR SAFETY: Before leaving or servicing machine, stop on level surface, turn off machine, and remove key.



2. Remove the squeegee suction hose from the top of the squeegee.



3. Attach the squeegee suction hose to the end of the power wand vacuum hose using the white adapter.

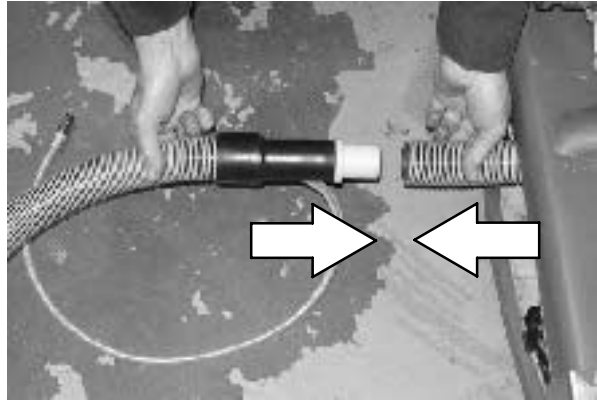

4. Push the power wand solution line into the quick-connect fitting on the machine. Pull on the hose to make sure it is connected.
5. Turn the machine power on.



6. Press the squeegee switch.



OPERATION

7. Press the power wand switch.

8. Squeeze the solution lever on the power wand to spray solution on the floor. Scrub the floor with the brush side of the cleaning tool.

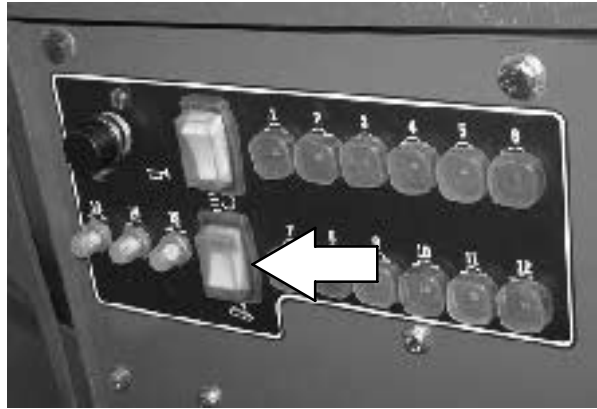

9. Vacuum up the solution by turning over the cleaning tool so the squeegee side is down.

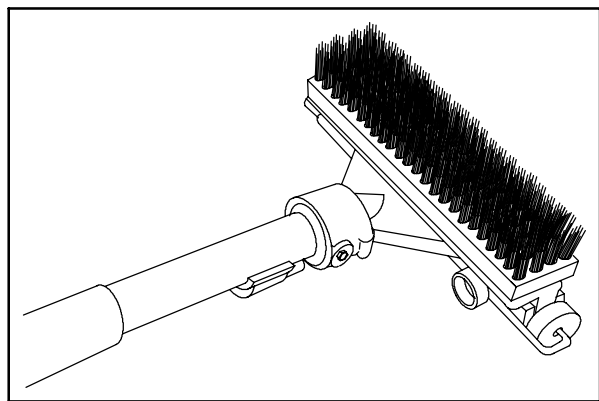

06202

If the power wand is hard to push or is not picking up the solution very well, adjust the roller wheels on the tool by turning the black adjustment knob.

NOTE: The wheels are properly adjusted when the squeegee blades deflect slightly while the tool is pushed back and forth.

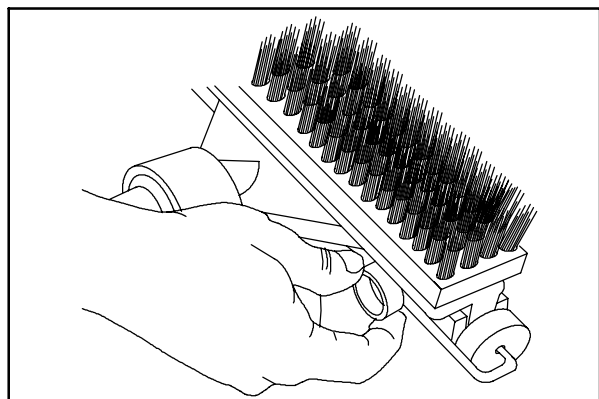

06604

10. Press the squeegee switch to stop the vacuum system.
11. Press the power wand switch.

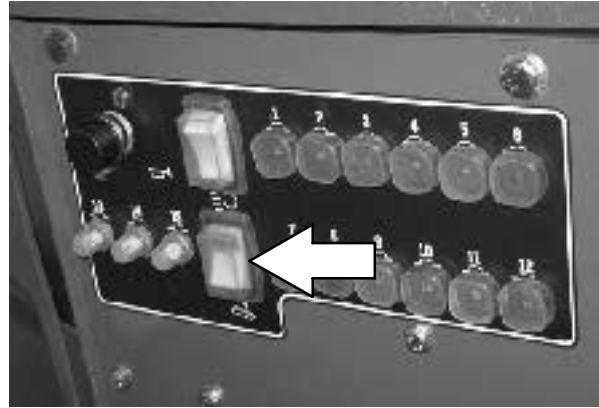

12. Turn the machine power off.
13. Disconnect the solution hose from the machine.
14. Disconnect the power wand from the squeegee suction hose.
15. Reconnect the squeegee suction hose to the squeegee.



OPERATION

VACUUM WAND

The vacuum wand uses the machine's vacuum system. The vacuum hose allows pick-up of spills that are out of reach of the machine.

⚠ WARNING: Flammable materials or reactive metals can cause an explosion or fire. Do not pickup.

1. Press the squeegee switch. When the rear squeegee lowers all the way to the floor, turn the machine power off.

FOR SAFETY: Before leaving or servicing machine, stop on level surface, turn off machine, and remove key.



2. Remove the squeegee suction hose from the top of the squeegee.



- Put together the wand and the wand hose.

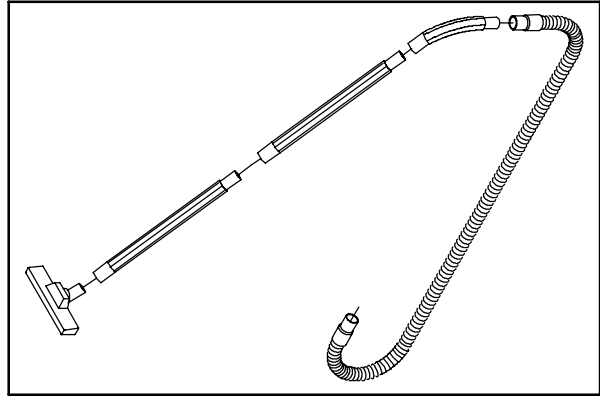

10080

- Attach the squeegee suction hose to the end of the vacuum hose.

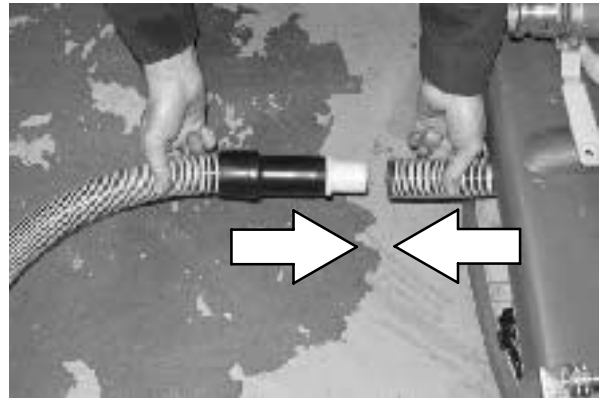

- Turn the machine power on.
- Press the squeegee switch.



OPERATION

7. Vacuum the floor.
8. Turn the machine power off.
9. Disconnect the vacuum hose from the squeegee suction hose.

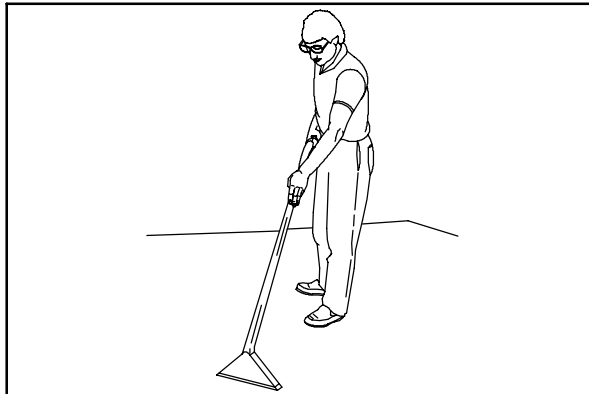

06599

10. Reconnect the squeegee suction hose to the squeegee.



POSITIVE DRAIN CONTROL VALVE

The positive drain control valve allows the operator to control the flow of liquid being drained from the tank. The positive drain control valve can be installed on either the recovery tank drain or solution tank drain.

1. Stop scrubbing.
2. Drive the machine next to a floor drain.
3. Turn the machine power off.

FOR SAFETY: Before leaving or servicing machine, stop on level surface, turn off machine, and remove key.

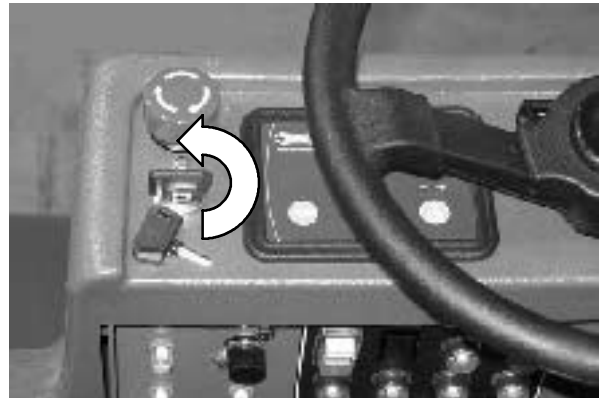

4. Lift the tank cover.



5. Slowly open the positive drain control valve to drain and clean the tank.
6. Close the positive drain control valve when through emptying and cleaning the tank.



OPERATION

ROLLOUT BATTERY

The rollout battery allows the operator a quick and easy way to remove and replace the batteries from the machine.

1. Drive the machine to a flat, dry surface.
2. Turn the machine power off.

FOR SAFETY: Before leaving or servicing machine, stop on level surface, turn off machine, and remove key.

3. Lift the operator seat to access the batteries. The support arm automatically engages when the seat is lifted all the way up.
4. Unplug the machine connector from the batteries.



5. Push the battery cart to the operators side of the machine. Line up the battery cart locks and the slots on the machine. Push the battery cart forward.

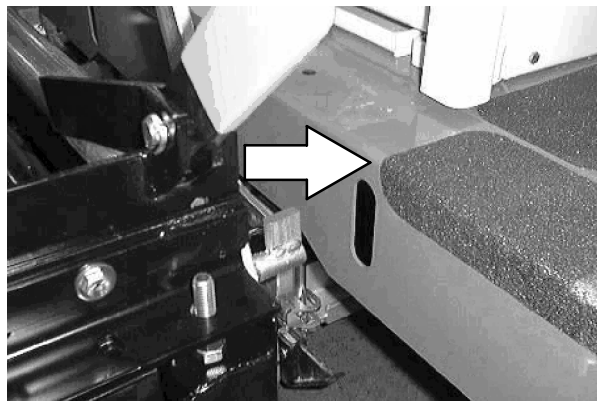

6. Lock the battery cart to the machine by pulling the battery cart locks towards the outside of the battery cart.

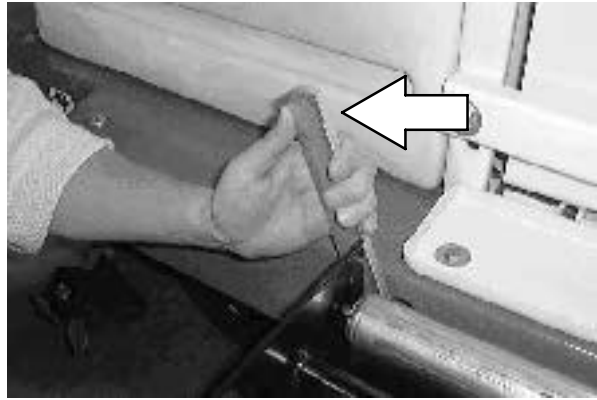

7. Set the battery cart floor lock by stepping down on the left side of floor lock.

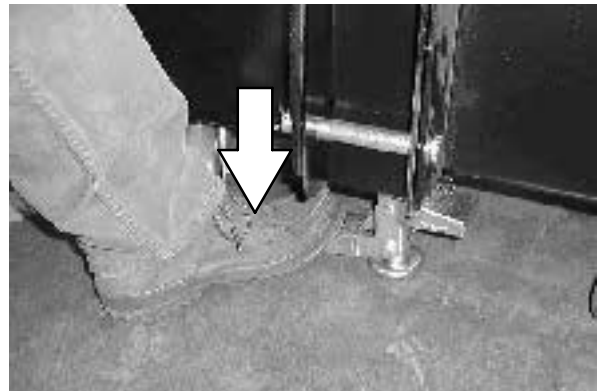

8. Adjust the battery cart rollers before rolling out the batteries. The battery cart rollers must be the same height as the machine battery rollers.

Raise battery cart rollers: With a wrench, loosen the jam nut and turn the bolt clockwise. Then tighten the jam nuts.

Lower battery cart rollers: With a wrench, loosen the jam nut and turn the bolt counter-clockwise. Then tighten the jam nuts.



OPERATION

9. Turn the knob on the machine's battery stop arm counter-clockwise until it stops turning.

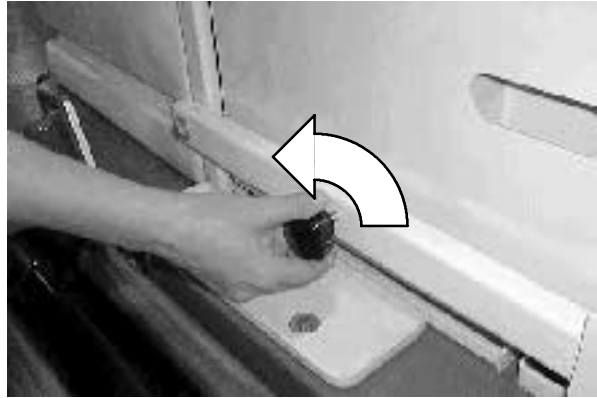

10. Raise the machine's battery stop arm all the way to the vertical position.

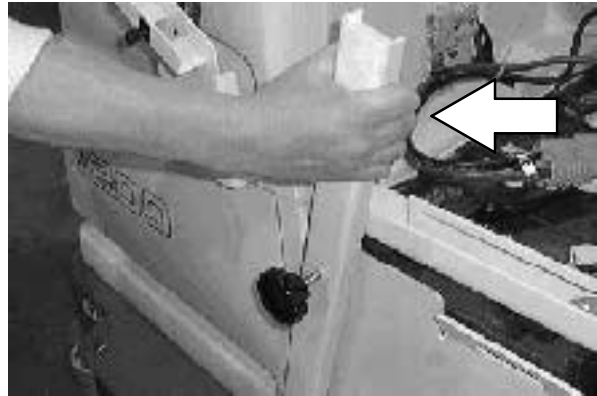

11. Raise the cart's battery stop bar by pushing down on the handle.

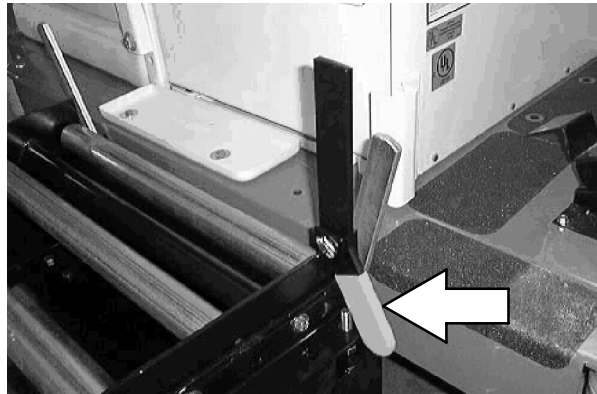

12. Grab the battery case slot and pull the battery case onto the battery cart.

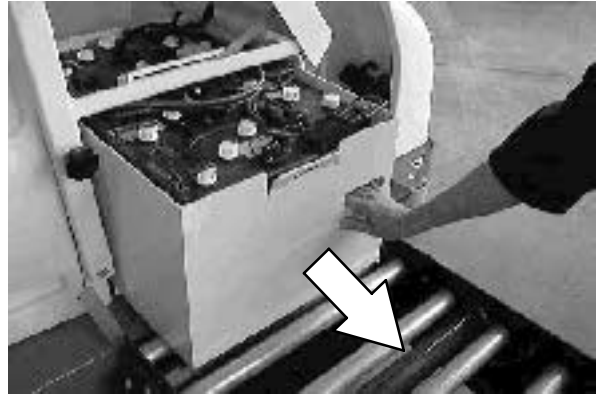

13. Lower the cart's battery stop bar by pulling up on the handle. This will keep the batteries from rolling off the cart when moving.

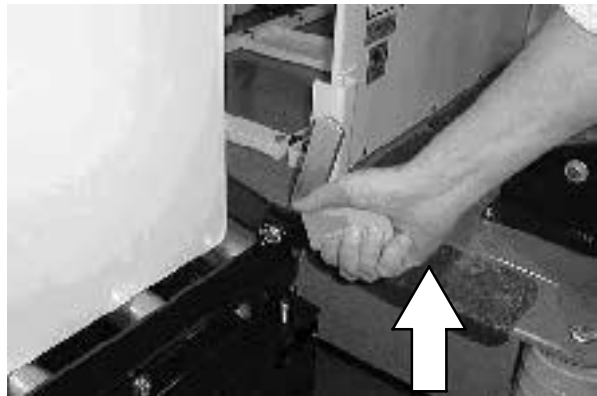

14. Release the battery cart from the machine by pushing the battery cart locks towards the inside of the battery cart.



OPERATION

15. Release the battery cart floor lock. To release floor lock, step down on the right side of floor lock.

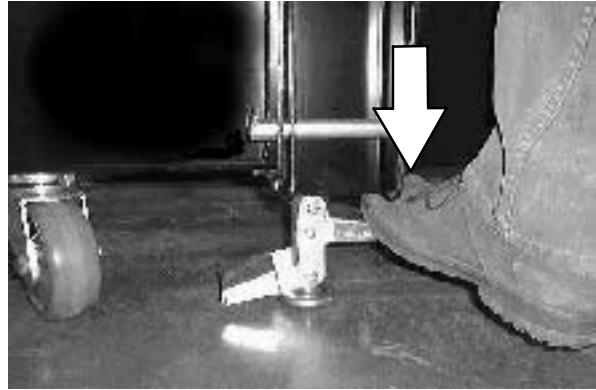

16. Pull the battery cart away from the machine.

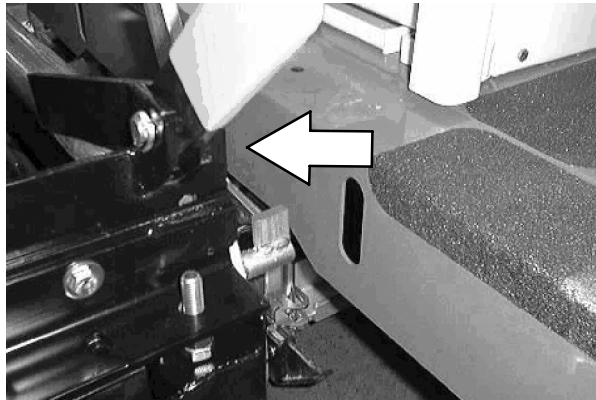

17. Reverse the previous steps to re-install batteries in the machine.

MACHINE TROUBLESHOOTING

| Problem | Cause | Remedy |
|--|--|--|
| Poor sweeping performance | Worn brush bristles | Replace brushes |
| | Sweeping brushes not adjusted | Adjust brushes |
| | Hopper full | Empty hopper |
| | Hopper skirts worn or damaged | Replace skirts |
| | Brush drive failure | Check with TENNANT representative for advice |
| Trailing water - poor or no water pickup | Worn squeegee blades | Rotate or replace squeegee blades |
| | Squeegee out of adjustment | Adjust squeegee |
| | Vacuum hose clogged | Flush vacuum hoses |
| | Vacuum fan inlet filter dirty | Clean inlet filter |
| | Debris caught on squeegee | Remove debris |
| | Vacuum hose to squeegee or recovery tank disconnected or damaged | Reconnect or replace vacuum hose |
| | Tank cover not completely closed | Check for obstructions |
| | Torn seals on recovery tank | Replace seals |
| Vacuum fan will not turn on | Recovery tank full | Drain recovery tank |
| | Foam filling recovery tank | Empty recovery tank |
| | | Use less or change detergent |
| | | Use a defoamer |
| Vacuum fan circuit breaker tripped | Reset circuit breaker | |
| Little or no solution flow to the floor | Solution tank empty | Fill solution tank |
| | Solution control rod broken or out of adjustment | Replace and/or adjust rod |
| | Solution flow turned off | Turn solution flow on |
| | Solution supply lines plugged | Flush solution supply lines |
| | Solution solenoid clogged or stuck | Clean or replace |
| | ES mode (option): ES switch off | Turn ES switch on |
| Poor scrubbing performance | Debris caught on scrub brushes | Remove debris |
| | Improper detergent or brush used | Check with TENNANT representative for advice |
| | Worn scrub brush(es) | Replace scrub brush(es) |
| | Scrub brush motor circuit breaker(s) tripped | Reset circuit breaker(s) |
| | | Reduce scrub brush down pressure |
| | | Uneven brush pressure, level scrub head |
| | | Broken brush drive belts on cylindrical scrub head, replace belt |
| | | Check with TENNANT representative for advice |
| | Low battery charge | Charge batteries until the charger automatically turns off |

OPERATION

| Problem | Cause | Remedy |
|--|---|---|
| FaST System does not operate | FaST switch is turned off | Turn on the FaST switch. |
| | FaST circuit breaker tripped | Determine cause and reset the 15A circuit breaker button |
| | Clogged FaST PAK supply hose and/or connector | Soak connector and hose in warm water and clean |
| | FaST PAK carton is empty or not connected | Replace FaST PAK carton and/or connect supply hose |
| | FaST system is not primed | To prime, operate the FaST solution system for 5 to 10 minutes. |
| | Clogged flow control orifice/screen | Remove and clean orifice/screen |
| | Faulty pump | Contact Tennant representative |
| | Clogged filter screen | Drain solution tank, remove and clean filter screen |
| | Faulty detergent timer module | Contact Tennant representative |
| ec-H2O Model: ec-H2O system indicator light blinking red | Mineral deposit build-up in module | Flush module (See <i>ec-H2O</i> MODULE FLUSH PROCEDURE) |
| ec-H2O Model: Alarm sounds | | |
| ec-H2O Model: ec-H2O system indicator light solid red | Defective module | Contact Service Center |
| ec-H2O Model: ec-H2O system indicator light does not turn on | Defective light or module | Contact Service Center |
| ec-H2O Model: No water flow | Clogged module | Contact Service Center |
| | Defective solution pump | Replace solution pump |

MAINTENANCE

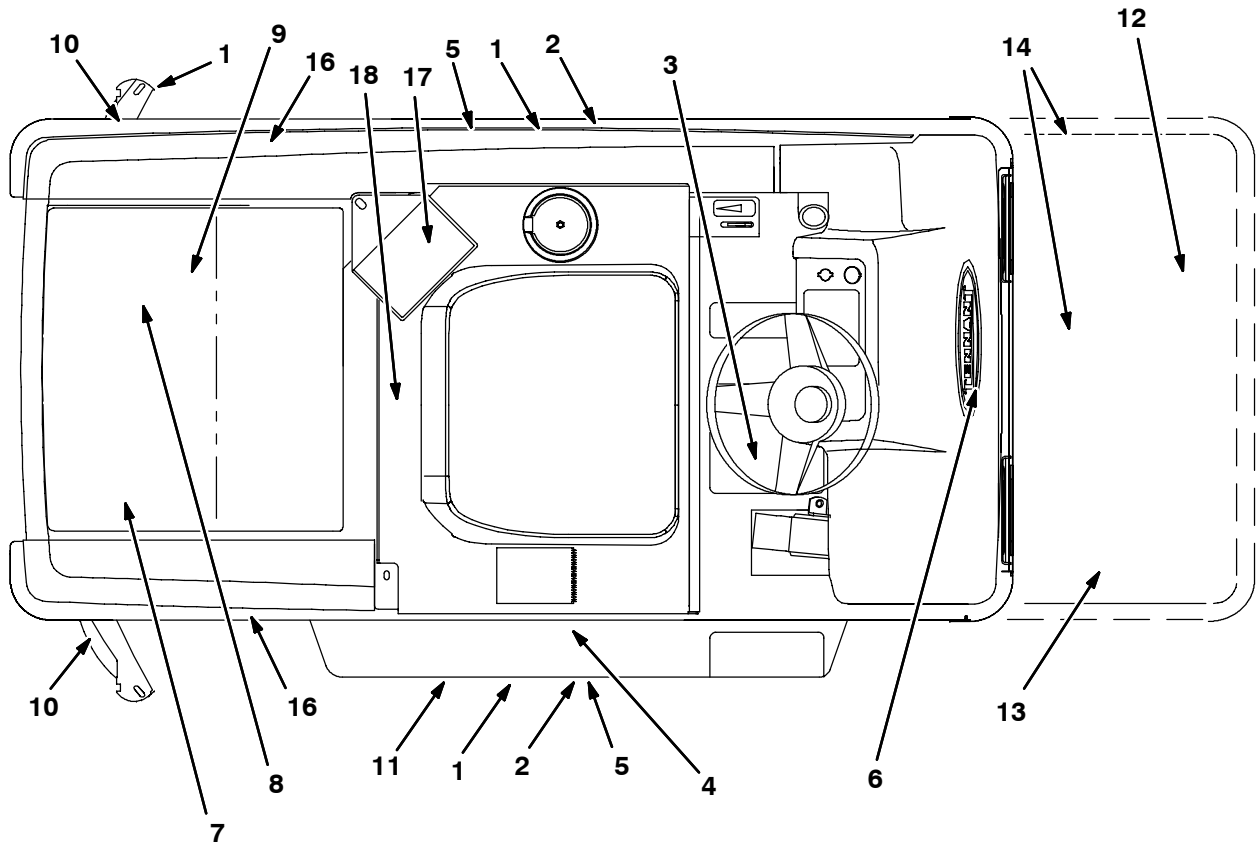

350790

MAINTENANCE CHART

NOTE: Check procedures indicated (■) after the first 50 hours of operation.

| Interval | Key | Description | Procedure | Lubricant/ Fluid | No. of Service Points |
|----------|-----|--|---|---------------------|-----------------------------|
| Daily | 1 | Side and rear squeegees | Check for damage and wear | - | 3 |
| | 2 | Scrub brushes | Check for damage, wear, debris | - | 2 |
| | 8 | Recovery tank | Clean tank | - | 1 |
| | 8 | Recovery tank, ES mode | Clean ES filter | - | 1 |
| | 7 | Solution tank, ES mode | Clean solution supply filter | - | 1 |
| | 9 | Vacuum fan inlet filter | Clean | - | 1 |
| | - | Machine | Check for leaks | - | 3 |
| | 11 | Cylindrical brushes only: debris trough | Clean | - | 1 |
| | 12 | Pre-Sweep brushes | Check for damage and wear | - | 2 |
| | 12 | Pre-Sweep debris hopper | Clean | - | 1 |
| | 17 | FaST PAK supply hose and connector | Clean and connect hose to storing plug when not in use | - | 1 |

MAINTENANCE

| Interval | Key | Description | Procedure | Lubricant/ Fluid | No. of Service Points |
|------------|-----|---|--------------------------------------|---------------------|-----------------------------|
| 50 Hours | 15 | Pre-Sweep cylindrical brushes | Check taper | - | 1 |
| | 5 | Cylindrical scrub brushes | Check taper and rotate front to rear | - | 2 |
| | 10 | Squeegee caster wheels and pivot points | Lubricate | SPL | 4 |
| | 4 | Battery cells | Check electrolyte level | DW | 3 |
| | 1 | Side and rear squeegees | Check deflection and leveling | - | 6 |
| | 14 | Pre-Sweep skirts and seals | Check for damage and wear | - | 4 |
| | 18 | FaST/Solution filter screen | Clean | - | 1 |
| 100 Hours | 5 | Cylindrical scrub brush drive belts | Check tension and wear | - | 2 |
| | 13 | Pre-Sweep brush drive belts | Check tension and wear | - | 2 |
| | 3 | Steering caster pivot bearing | Lubricate | SPL | 1 |
| 200 Hours | 4 | Battery terminals and cables | ■Check and clean | - | 12 |
| | 6 | Steering gear chain | Lubricate | GL | 1 |
| | 18 | FaST air filter (S/N 000000-015437) | Clean | - | 1 |
| 500 Hours | 9 | Vacuum fan motor(s) | Check motor brushes | - | 1 |
| | | Steering gear chain | ■Check deflection | - | 1 |
| 1000 Hours | 5 | Brush drive motors | Check motor brushes | - | 2 (4) |
| | 6 | Propelling motor | Check motor brushes | - | 1 |
| | 16 | Rear wheel nuts | ■Torque wheel nuts | - | 3 |
| | 18 | FaST injector filters (S/N 015438-) | Replace | - | 1 |

LUBRICANT/FLUID

DW . . . Distilled water

SPL . . . Special lubricant, Lubriplate EMB grease (TENNANT part no. 01433-1)

GL . . . SAE 90 weight gear lubricant

LUBRICATION

STEERING CASTER PIVOT BEARING

The steering caster bearing is located on the floorplate. Lubricate with Lubriplate EMB grease (TENNANT part no. 01433-1) every 100 hours.

**REAR SQUEEGEE CASTERS**

The rear squeegee casters are located on the back side of the rear squeegee. The rear squeegee casters each have two grease fittings. Lubricate the pivot point and caster bearing on each squeegee caster with Lubriplate EMB grease (TENNANT part no. 01433-1) every 50 hours.

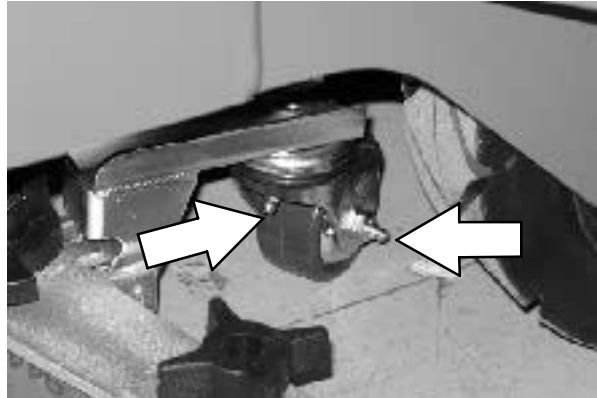
**STEERING GEAR CHAIN**

The steering gear chain is located directly above the front tire.

Lubricate with SAE 90 weight gear lubricant every 200 hours of use.

BATTERIES

The batteries are designed to hold their power for long periods of time. The lifetime of the batteries is limited to number of charges the batteries receive. To get the most life from the batteries, recharge them immediately when the battery discharge indicator begins to blink.

After every 200 hours of use check for loose battery connections and clean the surface of the batteries, including terminals and cable clamps, using a strong solution of baking soda and water. Brush the solution sparingly over the battery tops. Do not allow any baking soda solution to enter the batteries. Use a wire brush to clean the terminal posts and the cable connectors. Wipe off all cleaning solution residue. After cleaning, apply a coating of clear battery post protectant to the terminals and the cable connectors. Keep the tops of the batteries clean and dry.

Objects made of metal can potentially short circuit the batteries. Keep all metallic objects off the batteries. Replace any worn or damaged wires.

Check the electrolyte level in each battery cell before and after charging, and after every 50 hours of operation. Do not charge the batteries unless the fluid is slightly above the battery plates. If needed, add just enough distilled water to cover the plates. Never add acid to the batteries. Do not overfill. Always keep the battery caps on, except when adding water or taking hydrometer readings.

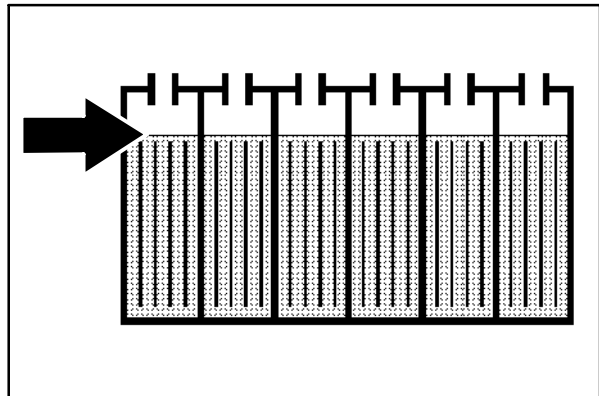
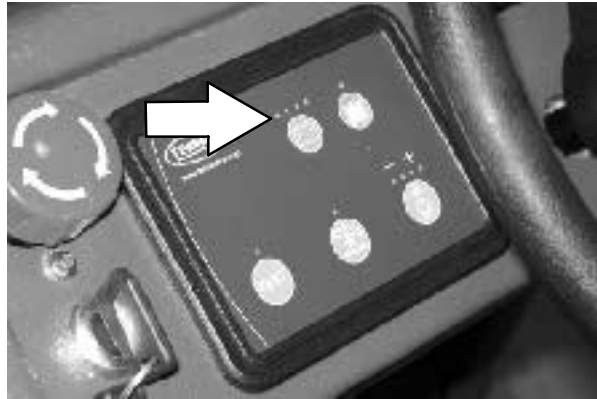

Using a hydrometer, measure the specific gravity to determine the charge level and condition of the batteries. If one or more of the battery cells test lower than the other battery cells (0.050 or more), the cell is damaged, shorted, or is near failure. Completely recharge the batteries, then retest them.

NOTE: Do not take readings immediately after adding distilled water. If the water and acid are not thoroughly mixed, the readings may not be accurate. Check the hydrometer readings against the following chart to determine the remaining battery charge level:

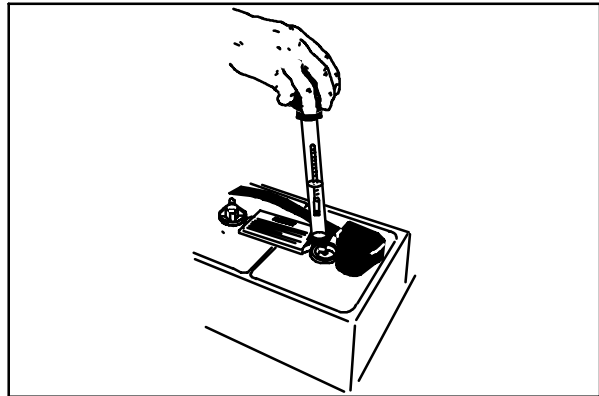

04380

| SPECIFIC GRAVITY at 27° C (80° F) | BATTERY CHARGE |
|--|---------------------------|
| 1.265 | 100% Charged |
| 1.223 | 75% Charged |
| 1.185 | 50% Charged |
| 1.148 | 25% Charged |
| 1.110 | Discharged |

NOTE: If the readings are taken when the battery electrolyte is any temperature other than 27 C (80 F), the reading must be temperature corrected. Add or subtract to the specific gravity reading 0.004, 4 points, for each 6 C (10 F) above or below 27 C (80 F).

CHARGING THE BATTERIES

1. Drive the machine to a flat, dry surface.

NOTE: Make sure the area is well ventilated.

2. Turn the machine power off.

FOR SAFETY: Before leaving or servicing machine, stop on level surface, turn off machine, and remove key.

3. Lift the operator seat to access the batteries. The support arm automatically engages when the seat is lifted all the way up.



4. Check the water level in all battery cells.

MAINTENANCE

If the level is low, add just enough distilled water to cover the plates. **DO NOT OVERFILL.** The batteries can overflow during charging due to expansion.

NOTE: Make sure the battery caps are in place while charging.

FOR SAFETY: When maintaining or servicing machine, avoid contact with battery acid.

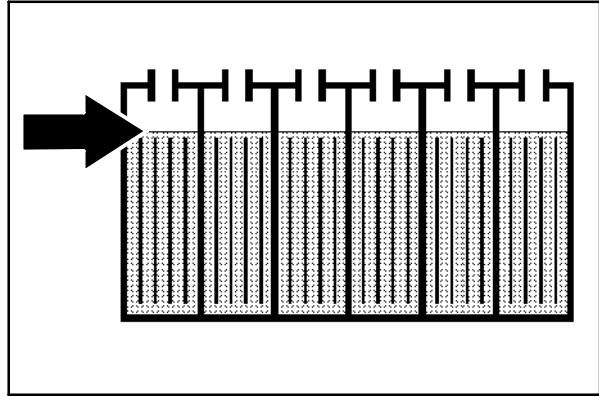

5. Unplug the machine connector from the batteries.

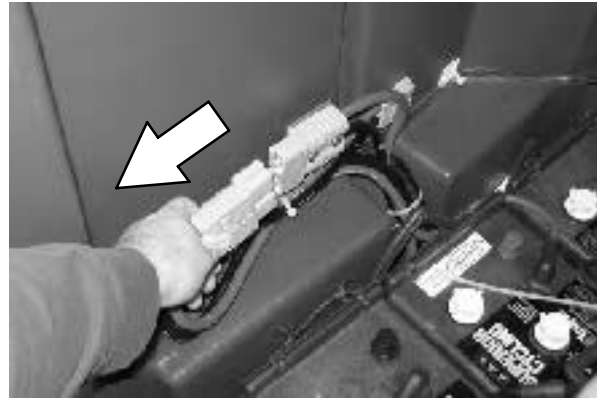

6. Plug the charger connector into the battery connector.



WARNING: Batteries emit hydrogen gas. Explosion or fire can result. Keep sparks and open flame away. Keep covers open when charging.



7. Plug the battery charger into the wall outlet.

NOTE: Refer to the instructions provided by the charger manufacturer for more detailed information.

8. The TENNANT charger will start automatically. When the batteries are fully charged, the TENNANT charger will automatically turn off.
9. After the charger has turned off, unplug the charger from the wall outlet.

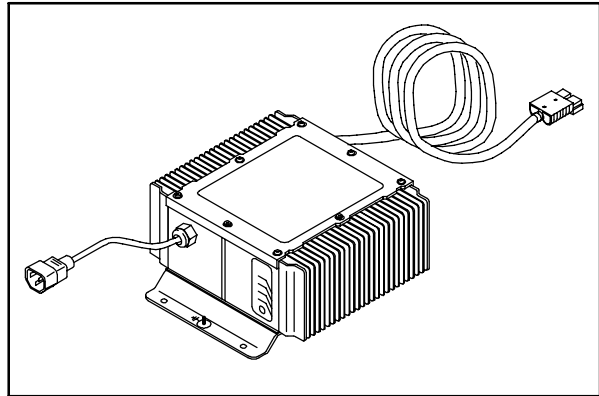

10. Unplug the charger connector from the battery connector on the machine.

FOR SAFETY: When maintaining or servicing machine, avoid contact with battery acid.



11. Connect the battery connector to the machine connector.
12. Check the electrolyte level in each battery cell after charging. If needed, add distilled water to raise the electrolyte level to about 12 mm (0.40 in) below the bottom of the sight tubes.
13. Lower the seat support by slightly raising it while pushing the support arm inward.

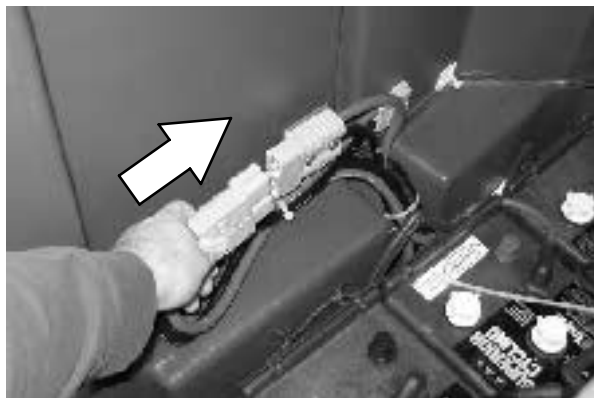

SELF-DIAGNOSTIC TEST

The machine is capable of running a self-diagnostic test of its electrical system and components.

1. Turn the machine power off.
2. Press and hold the squeegee switch while turning the machine power on. Continue holding the squeegee switch for five seconds, then release the switch.
3. While the self-diagnostic test is running, the battery discharge indicator on the far right will flash. The machine systems will activate as follows:
 - The brushes and squeegee raise.
 - The vacuum fan starts and the squeegee lowers. The squeegee raises and the vacuum fan shuts off.
 - The scrub head lowers and raises.
 - The brushes turn on and off.
 - The solution valve turns on and off.
 - If the machine has the ES option, the ES pump turns on and off.
 - If the machine has FaST, the FaST system turns on and off.
 - The vacuum fan starts and shuts off.
 - The brushes turn on and off.



4. If the electrical system passes the self-diagnostic test, the indicator light above the squeegee switch will illuminate (green).

If the self-diagnostic test finds an error in the system, the recovery tank full indicator will illuminate (red).

To determine which errors were found, hold down the ES or FaST switch and record which, if any, of the brush down pressure indicators illuminate. Repeat this operation with the squeegee switch and the scrubbing switch. Be sure to record which pressure indicators illuminate when each switch is held down.

Contact service personnel with the error code data.

5. Turn off the self-diagnostic test by turning off the machine power.

ELECTRIC MOTORS

The carbon brushes on the vacuum fan motor should be inspected after every 500 hours of machine operation. The carbon brushes on the scrub brush motors, propelling motor, Pre-Sweep main brush and side brush motors should be inspected after every 1000 hours of machine operation.

PRE-SWEEP BRUSHES

The Pre-Sweep assembly is equipped with *disk* and *cylindrical* brushes. Check the brushes daily for wire or string tangled around the brush or brush drive hub. Check the brushes daily for damage and wear.

The side brush (option) is a disk brush. Check the brush daily for wire or string tangled around the brush or brush drive hub. Check the brush daily for damage and wear.

PRE-SWEEP DISK BRUSHES

The disk brushes should be replaced if a large number of bristles are missing or if bristle length is less than 10 mm (0.38 in).

REPLACING THE DISK BRUSHES

1. Turn the machine power on.
2. Press the bottom of the Pre-Sweep switch to raise the Pre-Sweep assembly and stop sweeping.
3. Turn the machine power off.

FOR SAFETY: Before leaving or servicing machine, stop on level surface, turn off machine, and remove key.

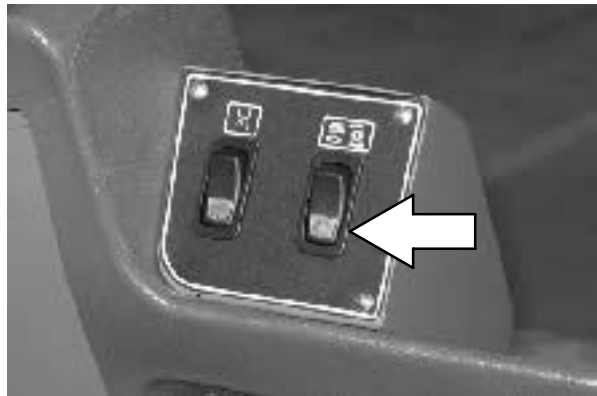

4. Pull the cotter pin from the end of the retaining pin. Remove the side brush retaining pin from the side brush drive shaft.

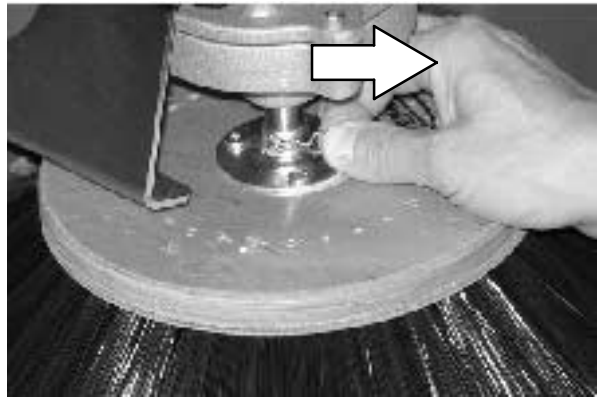

5. Remove the old side brush.

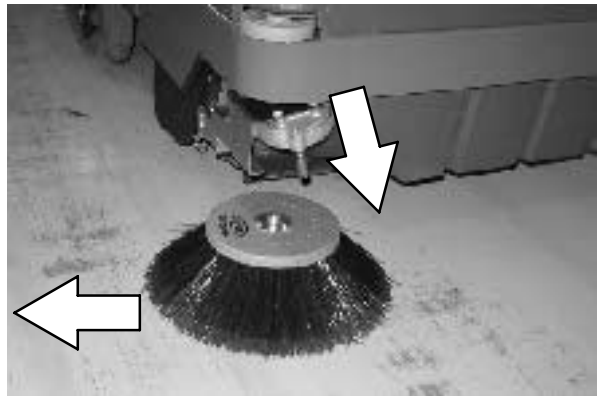

6. Slide the new side brush onto the side brush drive shaft.

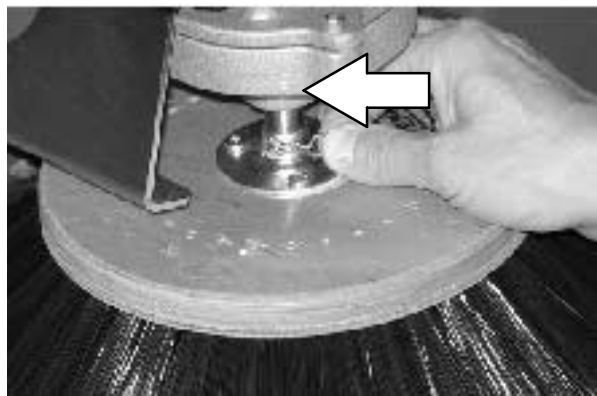

7. Insert the side brush retaining pin through the side brush hub and shaft. Replace the cotter pin in the end of the retaining pin.

PRE-SWEEP CYLINDRICAL BRUSH

Check the brush taper every 50 hours of machine operation for maximum brush life and best sweeping performance.

The cylindrical brush should be replaced if large amounts of bristles are missing, or if the remaining bristle length is less than 10 mm (0.38 in).

CHECKING AND ADJUSTING CYLINDRICAL BRUSH PATTERN

1. Apply chalk (or another material that will not easily blow away), to a smooth, level section of the floor.
2. Drive the machine so the Pre-Sweep assembly is centered in the chalk.
3. Block the front or rear wheels to prevent the machine from moving.
4. Lower the Pre-Sweep assembly in the chalked area. Slowly press down on the directional pedal until the Pre-Sweep brush begins to sweep. Allow the machine to sweep in the same place for 15 to 20 seconds.

NOTE: If chalk or other material is not available, allow the brush to spin on the floor for two minutes. A polish mark will remain on the floor.

5. Raise the Pre-Sweep assembly and move the machine away from the chalked area. Turn the machine power off.

6. Observe the shape of the brush pattern. If the brush pattern has parallel sides, the brush does not need adjustment.

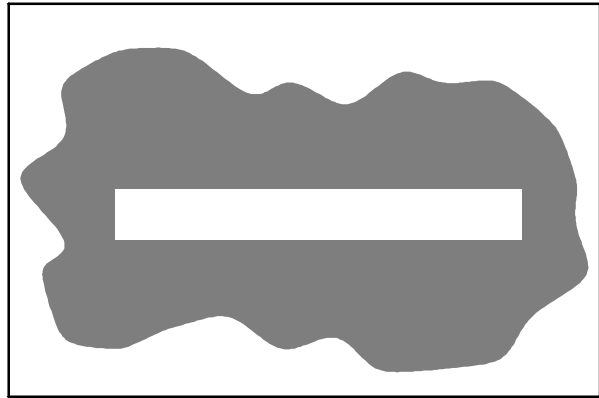

10355

If the brush pattern is tapered, the brush needs adjustment to straighten the brush pattern.

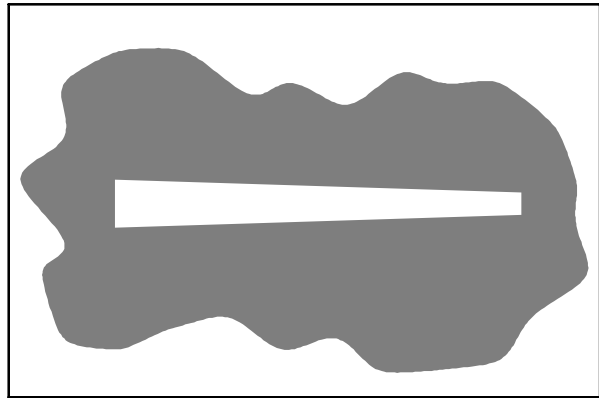

10356

- A. To adjust the brush taper, loosen the two lock nuts on the left hand brush arm.
- B. Turn the machine power on and lower the Pre-Sweep assembly. Allow the brush to float in place for 15 to 20 seconds.
- C. Tighten the two lock nuts on the left hand brush arm.

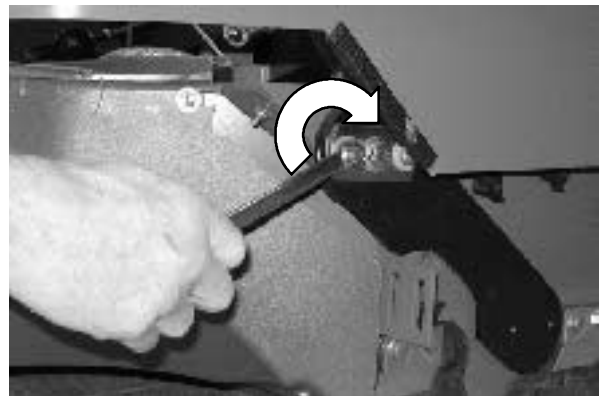
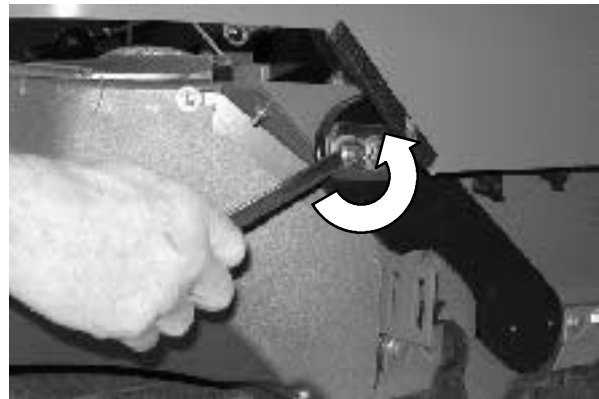

MAINTENANCE

- D. Check the brush pattern again and readjust as necessary until the width of the pattern is the same along the length of the brush pattern.

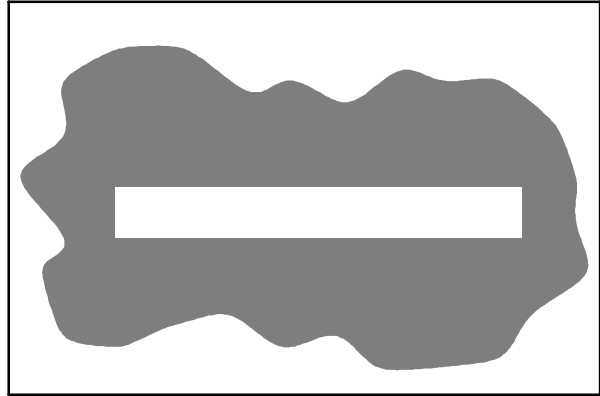

10355

REPLACING THE PRE-SWEEP CYLINDRICAL BRUSH

1. Turn the machine power on.
2. Lower the Pre-Sweep assembly.
3. Turn the machine power off.

FOR SAFETY: Before leaving or servicing machine, stop on level surface, turn off machine, and remove key.

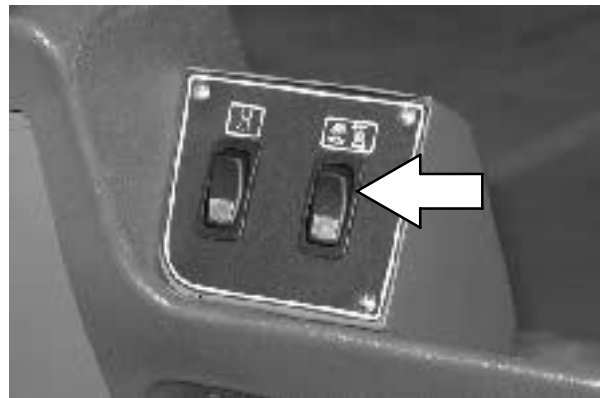

4. Loosen and remove the brush idler hex screw from the front of the idler plate.

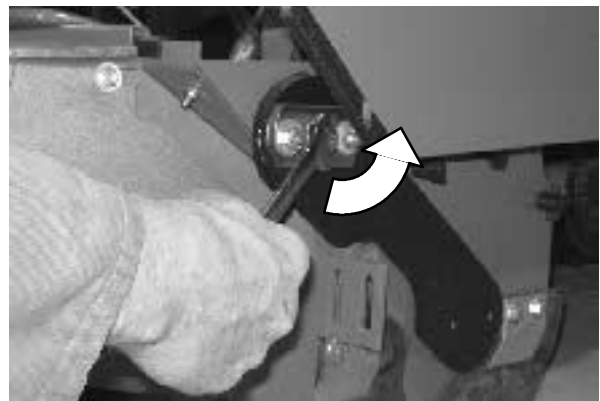

5. Loosen and remove the four brush housing door knobs. Set the brush housing idler plate aside.



6. Remove the cylindrical brush and replace with a new brush.

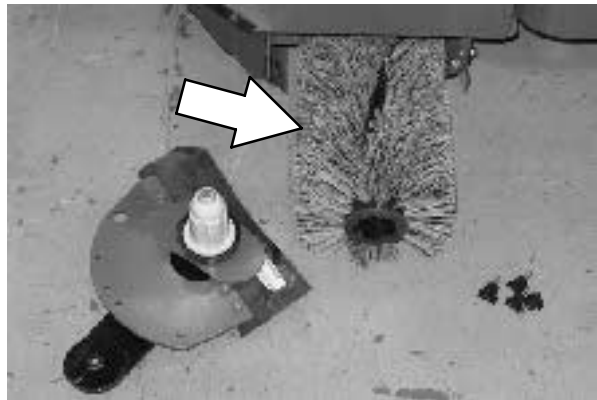

7. Guide the slotted end of the new brush onto the drive hub.

8. Replace the brush idler plate, and secure with the four brush housing door knobs and hex screw on the front of the idler plate.

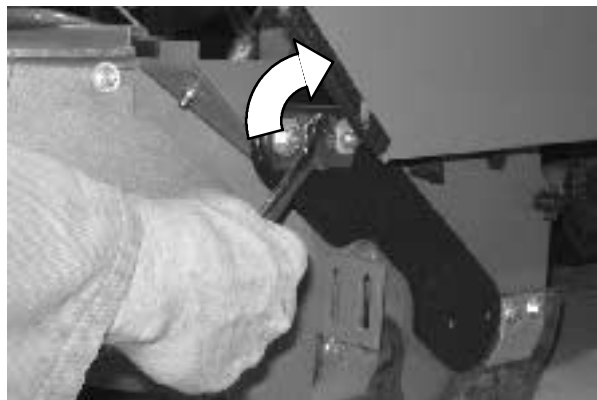

9. Check the new brush for proper adjustment. Readjust if necessary.

SCRUB BRUSHES

The machine can be equipped with either *disk* or *cylindrical* scrub brushes. Check scrub brushes daily for wire or string tangled around the brush or brush drive hub. Also check for brush damage and wear.

DISK SCRUB BRUSHES

The disk brushes should be replaced if a large number of bristles are missing or if bristle length is less than 10 mm (0.38 in).

NOTE: Replace worn brushes in pairs. Scrubbing with brushes of unequal bristle length will result in diminished scrubbing performance.

REPLACING THE DISK SCRUB BRUSHES

1. Raise the scrub head.
2. Turn the machine power off.

FOR SAFETY: Before leaving or servicing machine, stop on level surface, turn off machine, and remove key.

3. Raise the side squeegee and lock in the up position using the side squeegee lock arm.

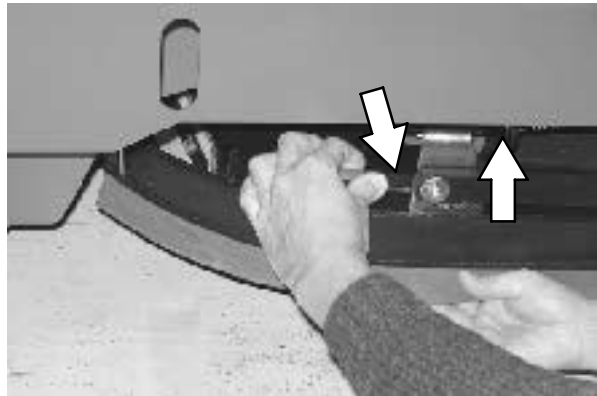

4. Turn the brush until you can see the brush spring clip.

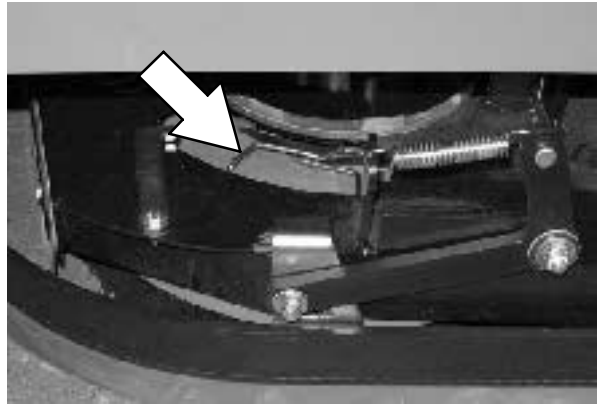

5. Press the brush spring clip together with your thumb and index finger. The brush will drop off the brush drive hub. Pull the brush out from under the scrub head.



6. Place the new scrub brush on the floor in front of the scrub head. Push the brush under the scrub head.



7. Line up the brush drive socket with the drive plug.
8. While pressing the brush spring clip together with your thumb and index finger, lift the scrub brush onto the drive plug.
9. Check to make sure the brush is securely mounted on the brush drive hub.

MAINTENANCE

10. Unlock the side squeegee lock plate and the side squeegee will return to the down position.

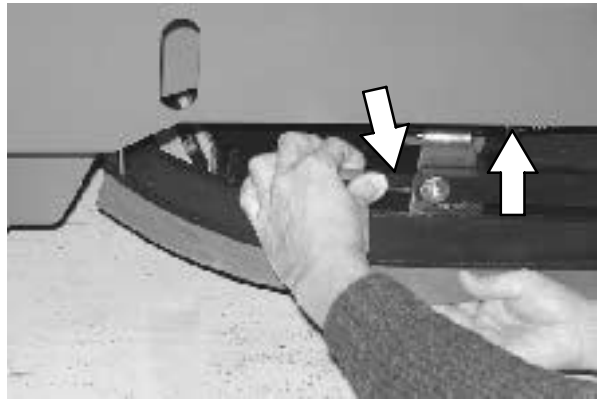

11. Repeat for the other brush.

CYLINDRICAL SCRUB BRUSHES

Check the brush taper and rotate the brushes from front-to-rear every 50 hours of machine operation for maximum brush life and best scrubbing performance.

The cylindrical brushes should be replaced if large amounts of bristles are missing, or if the remaining bristle length is less than 10 mm (0.38 in).

NOTE: Replace worn brushes in pairs. Scrubbing with brushes of unequal bristle length will result in diminished scrubbing performance.

NOTE: Fill the solution tank before checking or adjusting the brush pattern.

CHECKING AND ADJUSTING CYLINDRICAL SCRUB BRUSH PATTERN

1. Apply chalk (or another material that will not easily blow away), to a smooth, level section of the floor.
2. Raise the scrub head, and then position the brushes over the chalked area.
3. Block the front or rear wheels to prevent the machine from moving.
4. Lower the scrub head in the chalked area. Slowly press down on the directional pedal until the brushes begin to sweep. Allow the machine to sweep in the same place for 15 to 20 seconds.

NOTE: If chalk or other material is not available, allow the brushes to spin on the floor for two minutes. A polish mark will remain on the floor.

5. Raise the scrub head and move the machine away from the chalked area. Turn the machine power off.

MAINTENANCE

6. Observe the shape of the brush patterns. If the brush patterns have parallel sides, the brushes do not need adjustment.

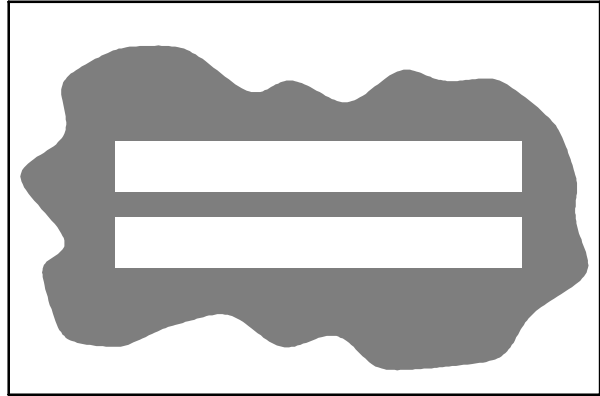

10355

If one, or both of the brush patterns are tapered, the brushes need adjustment to straighten the brush pattern.

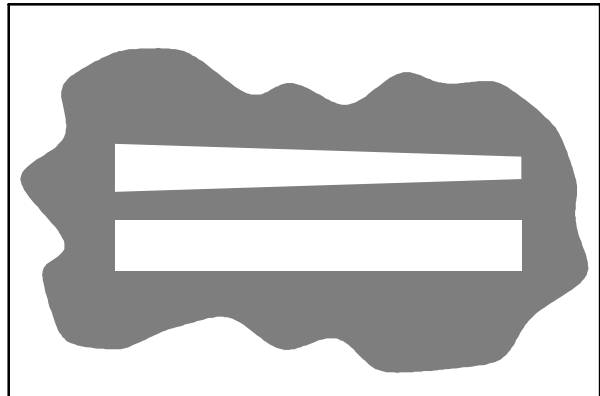

10356

- A. To adjust brush taper, push downward on the mounting spring and idler door until the top of the door releases from the scrub head. Pull the bottom of the door outward, then pull the idler door and idler plug off the brush.



- B. While holding the flat end of the idler shaft with a wrench, loosen the mounting screw on the outside of the idler door.

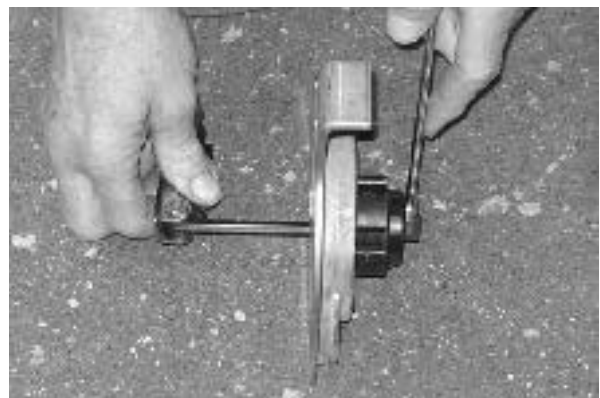

- C. Turn the idler shaft to raise or lower the end of the brush as needed to straighten the brush pattern. Tighten the mounting screw.
- D. Check the brush patterns again and readjust as necessary until both patterns are the same.

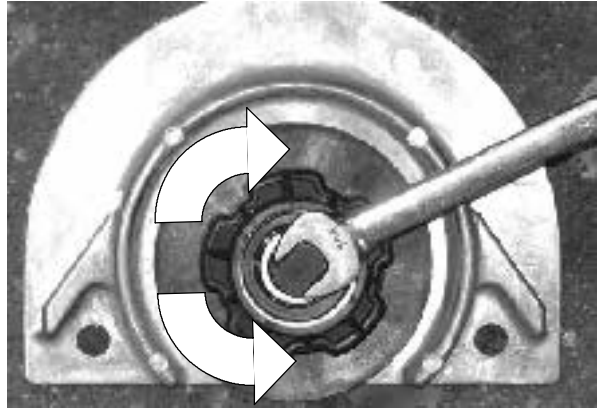

- 7. If one brush pattern is wider than the other, the scrub head needs to be leveled.

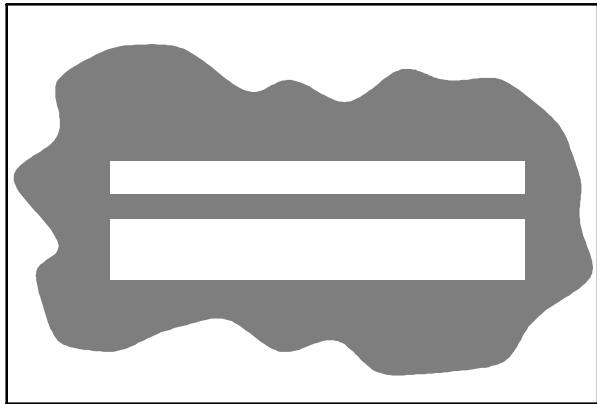

350630

Level the scrub head by turning the scrub head links. Both scrub head links should be adjusted equally.

Check the brush patterns again and readjust as necessary until both patterns are the same.

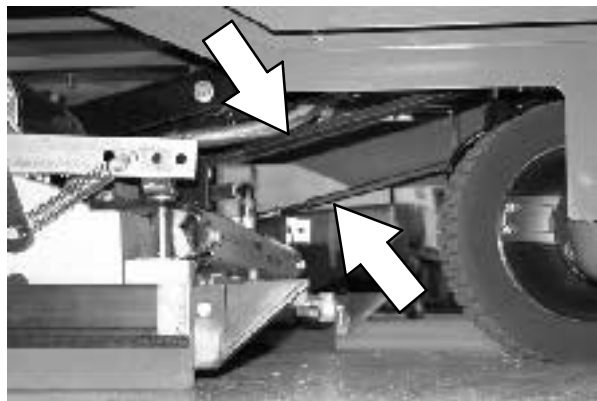

MAINTENANCE

REPLACING THE CYLINDRICAL SCRUB BRUSHES

1. Press the scrubbing switch. When the scrub head is approximately 25 mm (1 in) from the floor, turn the machine power off.

FOR SAFETY: Before leaving or servicing machine, stop on level surface, turn off machine, and remove key.



2. Remove the cotter pin that holds the side squeegee in place. Swing the squeegee away from the scrub head.

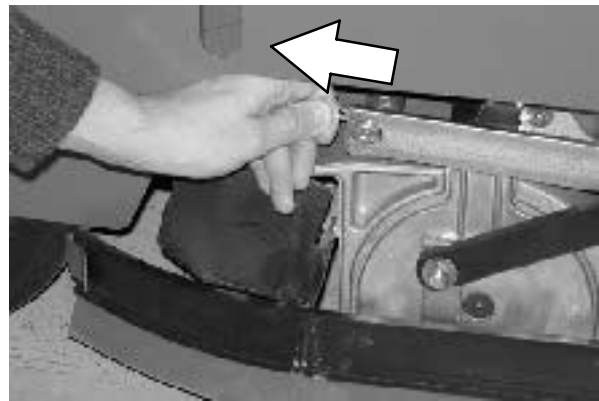

3. Push downward on the mounting spring and idler door until the top of the door releases from the scrub head. Pull the bottom of the door outward, then pull the idler door and idler plug off the brush.



4. Pull the old brush out of the scrub head.

5. Position the brush with the *double row end towards you*. Guide the new brush onto the drive hub.
6. Insert the Idler plug (on the inside of the idler door), into the brush.

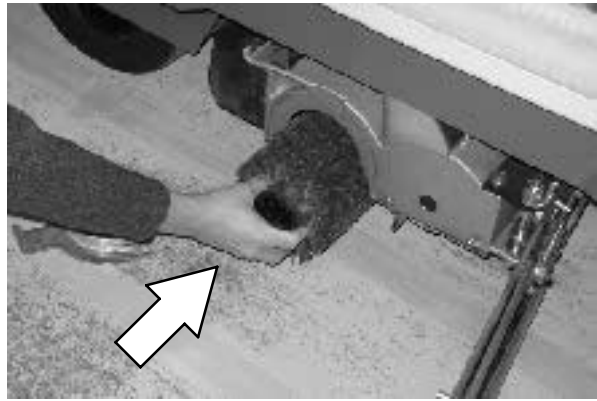

7. Push down on the door to catch the door in the scrub head, then pull up on the door to latch it into the spring.
8. Repeat for the other brush on the other side of the scrub head.

NOTE: Each side of the scrub head is stamped with a letter. The idler door of that side of the scrub head is stamped with the same letter. Make sure the letter on the door matches the letter on the scrub head when replacing the doors.

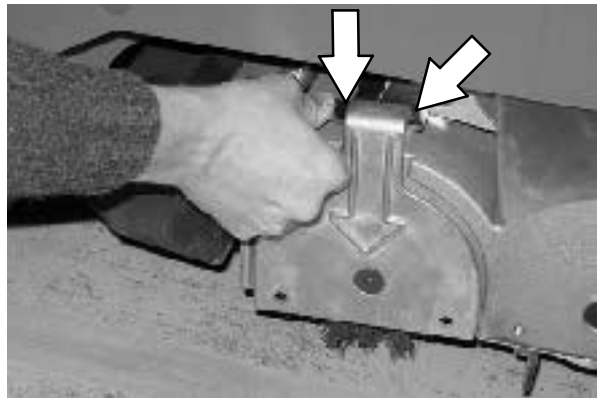

SOLUTION SYSTEM

RECOVERY TANK

The recovery tank holds recovered solution. Clean and drain the recovery tank after each use. The outside of the tank can be cleaned with vinyl cleaner.

ES mode: Flush out the recovery tank with clean water. Rinse the filter and the sensor floats near the top of the tank.

NOTE: *DO NOT* use steam to clean the tanks. Excessive heat can damage the tanks and components.



Thoroughly rinse the sensor floats inside the recovery tank after each use.



The vacuum fan inlet filter is located near the recovery tank.

Check the vacuum fan inlet filter daily. Clean inlet filter with a damp cloth or hose when dirty. Allow filter to dry completely before replacing it into machine.



To replace the vacuum fan inlet filter, make sure that the filter is installed properly by aligning the arrows.

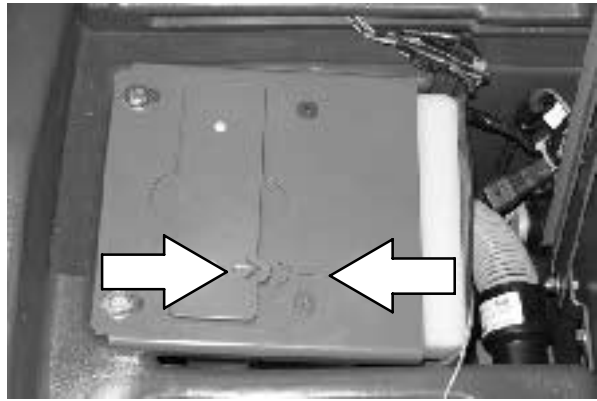

SOLUTION TANK

The solution tank holds the cleaning solution.

If deposits form on the bottom of the tank, rinse the tank and with a strong blast of warm water.

ES option: The solution tank should be drained and cleaned daily. Rinse the sensor float near the top of the solution tank off with a hose after each use.

The solution tank contains one standard solution filter. If the filter becomes dirty, the solution flow will be reduced. Check and clean this filter regularly.

NOTE: *DO NOT* use steam to clean the tanks. Excessive heat can damage the tanks and components.

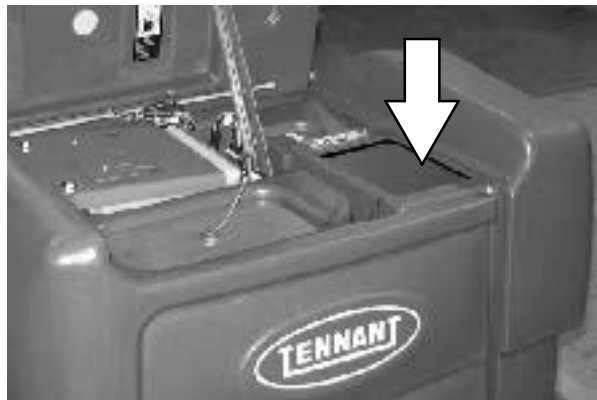

FaST SYSTEM

FaST SUPPLY HOSE CONNECTOR

The FaST supply hose connector is located below the FaST PAK holder. Soak the connector in warm water if detergent buildup is visible. When a FaST PAK carton is not installed, store the supply hose connector on the storing plug to prevent the hose from clogging.

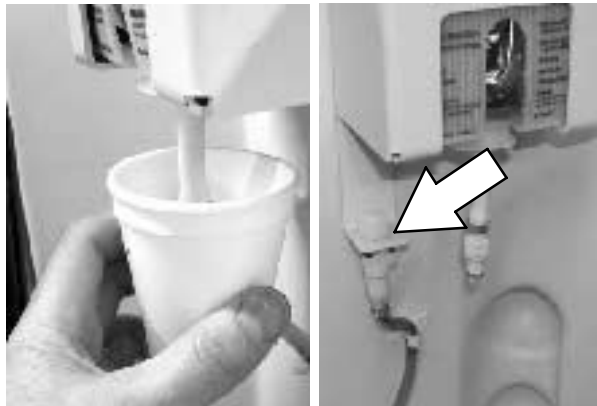

MAINTENANCE

FaST / SOLUTION FILTER SCREEN

The FaST / solution filter screen is located under the machine. It filters the water from the solution tank as it flows into the FaST system.

Remove the filter screen bowl and clean the filter screen after every 50 hours of FaST scrubbing. Empty the solution tank before removing the filter.

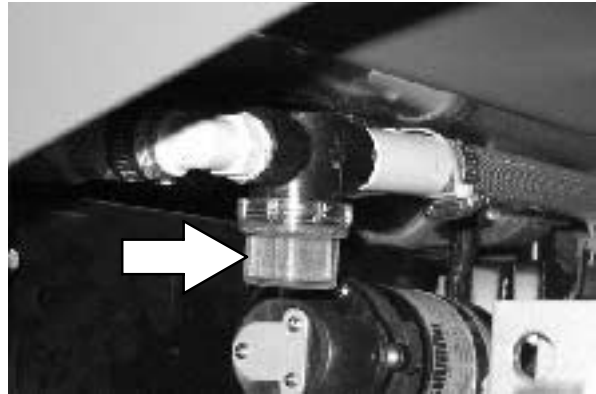

FaST SYSTEM AIR PUMP FILTER (S/N 000000-015437)

The FaST system air pump filter is located on the side of the air pump.

Remove and clean out the air filter with compressed air after every 200 hours of FaST scrubbing.

FOR SAFETY: When servicing machine, wear eye protection when using pressurized air or water.

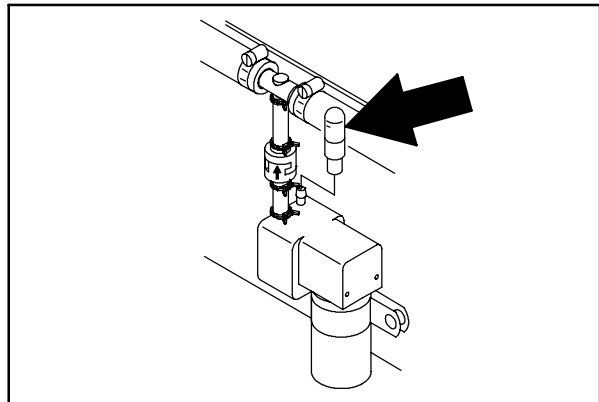

FaST SYSTEM INJECTOR FILTERS (S/N 015438-)

The FaST system injector filters are located under the machine.

Replace the FaST system injector filters after every 1000 hours of operation. Empty the solution tank before replacing the filters.



ec-H2O MODULE FLUSH PROCEDURE

This procedure is only required when an alarm sounds and the ec-H2O system indicator light begins to blink red.

1. Drain the solution tank and recovery tank of all water.
2. Pour 3 gallons (11.4 liters) of white or rice vinegar into the solution tank at full strength. Do not dilute.

*NOTE: Use **white or rice vinegar** only. The acidity level should be between 4-8%. **Do not** use other acids for this procedure.*

FOR SAFETY: When servicing machine, wear protective gloves and eye protection when handling vinegar.

3. Disconnect the quick connect fitting and place the hose into a bucket.
4. Turn the key to the on (I) position.
5. Press and release the ec-H2O module flush switch to start the flush cycle. The module is located behind the cover.

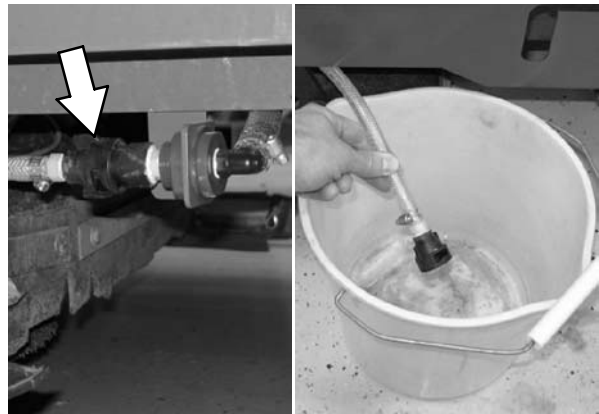

NOTE: The module will automatically shut off when the flush cycle is complete (approx. 7 minutes). The module must run the full 7 minute cycle in order to reset the system indicator light and alarm.

6. After the 7 minute flush cycle, drain, rinse and fill solution tank with clean water. Then press the flush switch again to rinse out any remaining vinegar from module. After 1-2 minutes, press the flush switch to turn off the module.
7. Re-attach the quick connect fitting. If the ec-H2O system indicator light continues to flash, repeat the flush procedure. If the problem persists, contact an Authorized Service Center.

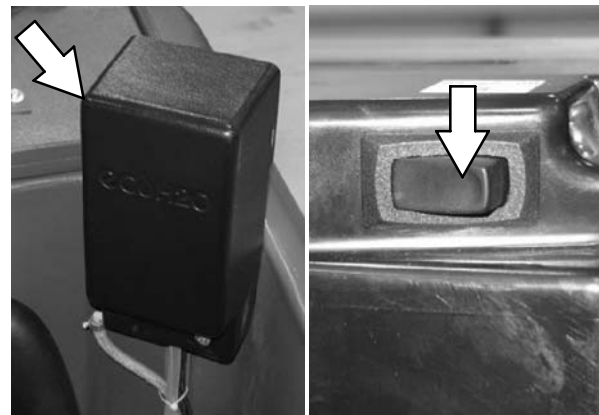

*NOTE: Be sure the cover is installed back onto the ec-H2O module before operating the machine. **Do Not** operate the machine without the cover installed on the ec-H2O module.*

REAR SQUEEGEE ASSEMBLY

The squeegee assembly channels water into the vacuum fan suction. The front blade channels the water, and the rear blade wipes the floor.

Check the squeegee blades for damage and wear daily. Rotate or replace either of the squeegee blades if the leading edge is torn or worn half-way through the thickness of the blade.

The squeegee can be adjusted for leveling and deflection. The deflection and leveling of the squeegee blades should be checked daily, or when scrubbing a different type of floor.

The squeegee assembly can be removed from the squeegee pivot to prevent damage during transport of the machine.

REMOVING THE REAR SQUEEGEE ASSEMBLY

1. Lower the squeegee to approximately 25 mm (1 in) from the floor.
2. Turn the machine power off.
3. Remove the squeegee suction hose from the squeegee.

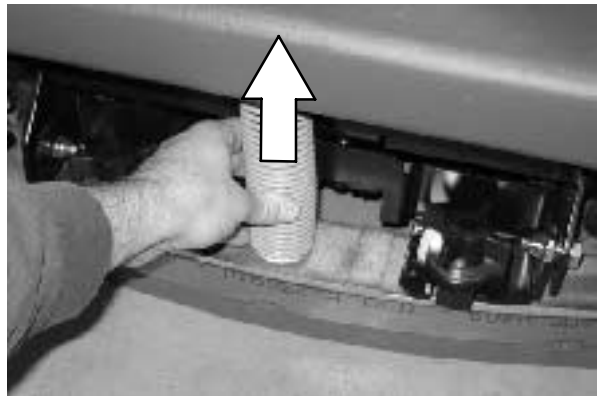

4. Remove both squeegee mounting knobs.

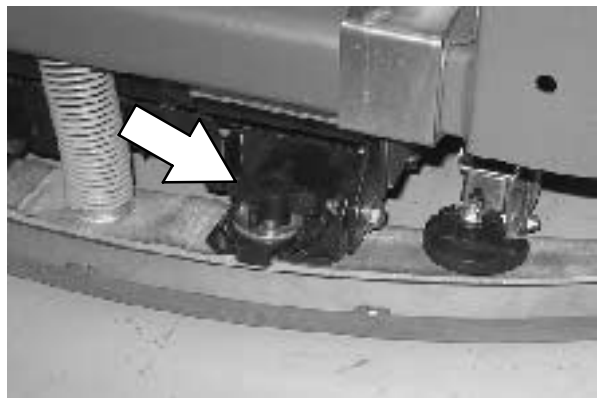

5. Pull the squeegee off the machine.

REPLACING THE REAR SQUEEGEE ASSEMBLY

1. Make sure the squeegee pivot is lowered.
2. Place the squeegee under the squeegee pivot.
3. Push the squeegee frame onto the squeegee pivot.
4. Tighten the mounting knobs.
5. Push the squeegee suction hose onto the squeegee fitting.

LEVELING THE REAR SQUEEGEE

Leveling of the squeegee assures even contact the length of the squeegee blade with the surface being scrubbed. Make sure this adjustment is done on an even, level floor.

1. Turn the machine power on.
2. Lower the squeegee.
3. Drive the machine forward a few feet and stop the machine.
4. Look at the deflection of the squeegee over the full length of the squeegee blade.
5. If the deflection is not the same over the full length of the blade, turn the squeegee leveling knob to make adjustments.

The squeegee leveling knob is located directly behind the squeegee suction hose. **DO NOT** disconnect the suction hose from the squeegee frame when leveling squeegee.

Turn the squeegee leveling knob counter-clockwise to increase the deflection at the ends of the squeegee.

Turn the squeegee leveling knob clockwise to decrease the deflection at the ends of the squeegee blade.

6. Drive the machine forward with the squeegee down to check the squeegee blade deflection.
7. Readjust the squeegee blade deflection if necessary.

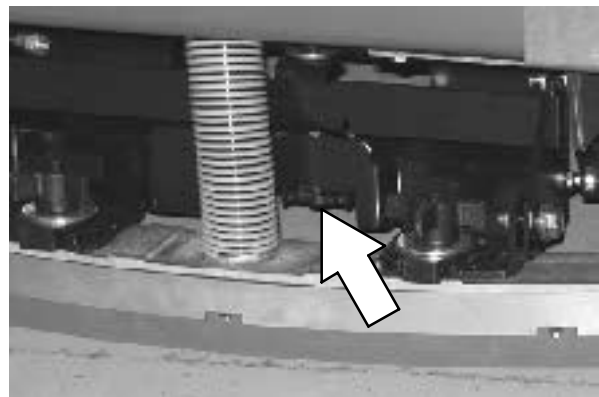

ADJUSTING REAR SQUEEGEE BLADE DEFLECTION

Deflection is the amount of curl the squeegee blade has when the machine moves forward while the squeegee lowered to the floor. The best deflection is when the squeegee wipes the floor just dry with a minimum amount of deflection.

1. Turn the machine power on.
2. Lower the squeegee.
3. Drive the machine forward, and look at the deflection of the squeegee blade. The correct amount of deflection is 12 mm (0.50 in) for scrubbing smooth floors and 15 mm (0.62 in) for rough floors.

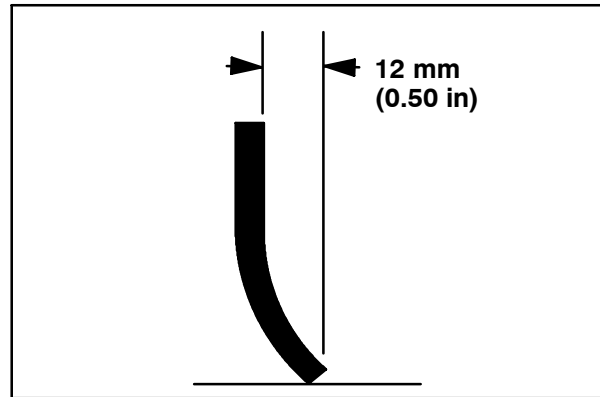

03719

4. Turn the machine power off.
5. To adjust the amount of deflection, turn the squeegee deflection cams clockwise to decrease the blade deflection.

Turn the squeegee deflection cams counter-clockwise to increase blade deflection.

6. Drive the machine forward again to check the squeegee blade deflection.
7. Readjust the squeegee blade deflection if necessary.

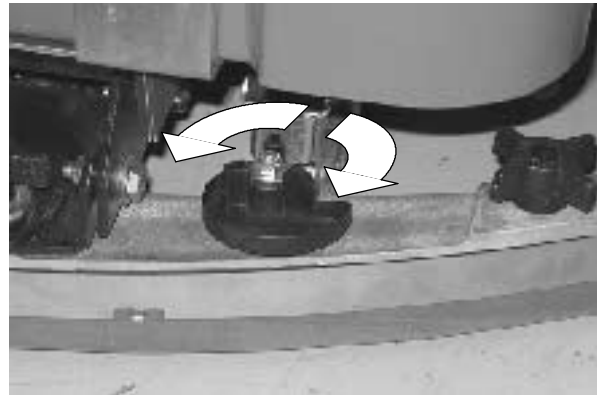

ADJUSTING THE SQUEEGEE GUIDE ROLLER

On the left end of the squeegee is a guide roller that guides the squeegee blade end along a wall. Loosen the nut at the top of the guide roller and move the roller in or out to adjust how close the end of the squeegee blade is to the wall. The squeegee blade end should be further away from the wall when the floor curves up into the wall.

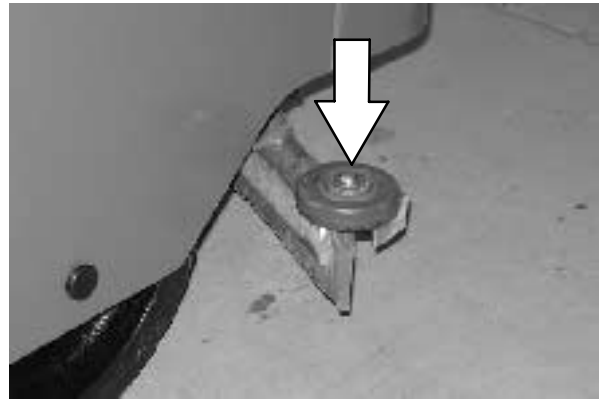

REAR SQUEEGEE BLADES

The rear squeegee has two squeegee blades, the front and rear. Each blade has four wiping edges. To use them all, start with one wiping edge. To use the next wiping edge, rotate the blade end-for-end. To use the next wiping edge, rotate the top edges down, bottom edges up. To use the last edge, rotate the blade end-for-end. Rotate squeegee blades when they become worn half-way through the thickness of the blade.

Replace damaged squeegee blades.

REPLACING OR ROTATING THE REAR SQUEEGEE BLADE

1. Make sure the squeegee is raised off the floor.
2. Turn the machine power off.

FOR SAFETY: Before leaving or servicing machine, stop on level surface, turn off machine, and remove key.

3. Loosen the two retainer knobs, one at each end of the squeegee.

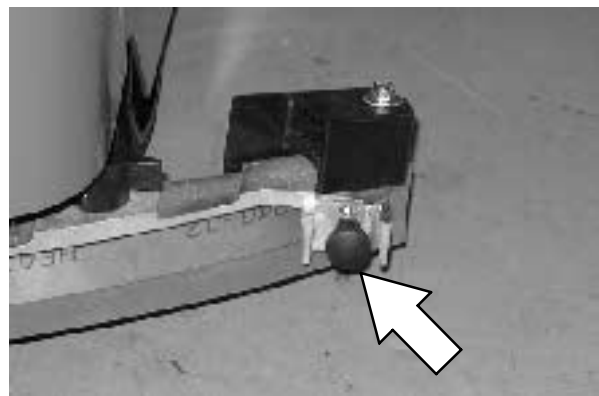

MAINTENANCE

4. Pull off the retaining band.

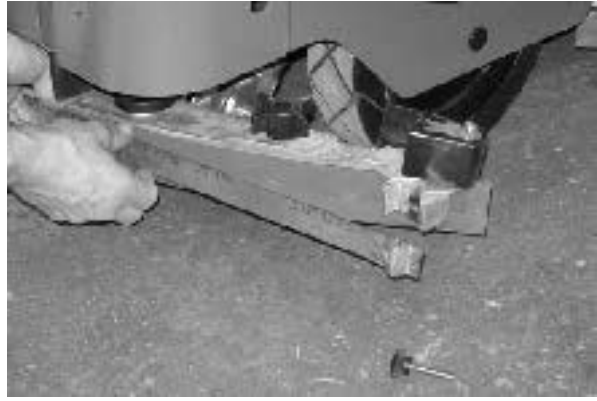

5. Pull off the rear squeegee blade.
6. Insert the rotated or new squeegee blade and then insert the retainer band.
7. Tighten the two retainer knobs until the ends of the front and rear squeegee blades touch. Do not over-tighten.

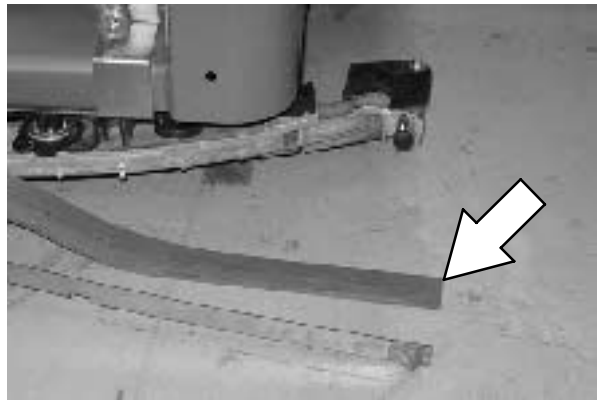

REPLACING OR ROTATING THE FRONT SQUEEGEE BLADE

1. Make sure the squeegee is raised off the floor.
2. Turn the machine power off.

FOR SAFETY: Before leaving or servicing machine, stop on level surface, turn off machine, and remove key.

3. Remove the squeegee from the machine. See *REMOVING THE REAR SQUEEGEE ASSEMBLY*.
4. Remove the rear squeegee blade and retainer. See *REPLACING OR ROTATING THE REAR SQUEEGEE BLADE*.
5. Loosen the two remaining knobs on top of the squeegee assembly.
6. Pull the retainer plate back and pull out the front squeegee blade of the squeegee frame.
7. Insert the rotated or new squeegee blade in the squeegee frame, lining up the slots in the blade with the tabs on the retainer plate.
8. Push the retainer plate forward. Tighten the two outside knobs on top of the squeegee assembly.
9. Insert the rear squeegee blade and retainer. Tighten the two rear blade retainer knobs until the ends of the front and rear squeegee blades touch. Do not over-tighten.
10. Install the squeegee assembly on the squeegee pivot. See *REPLACING THE SQUEEGEE ASSEMBLY*.
11. Adjust the squeegee blade leveling and deflection as stated in *LEVELING THE REAR SQUEEGEE* and *ADJUSTING REAR SQUEEGEE BLADE DEFLECTION*.

SIDE SQUEEGEE BLADES

The side squeegees control water spray and channel water into the path of the rear squeegee. Check the side squeegees for damage and wear daily.

Replace the side squeegee blades if they become damaged or lose their shape. Replace the squeegee deflectors if they become worn.

REPLACING SIDE SQUEEGEE BLADES

1. Raise the scrub head.
2. Turn the machine power off.

FOR SAFETY: Before leaving or servicing machine, stop on level surface, turn off machine, and remove key.

3. Remove the cotter pin, clevis pin, deflector, and the retainer bracket from the side squeegee and slide the squeegee out of the frame.
4. Slide a new squeegee blade into the frame.
5. Replace the retainer bracket, deflector, clevis pin, and cotter pin.
6. Repeat for the side squeegee on the other side of the scrub head.

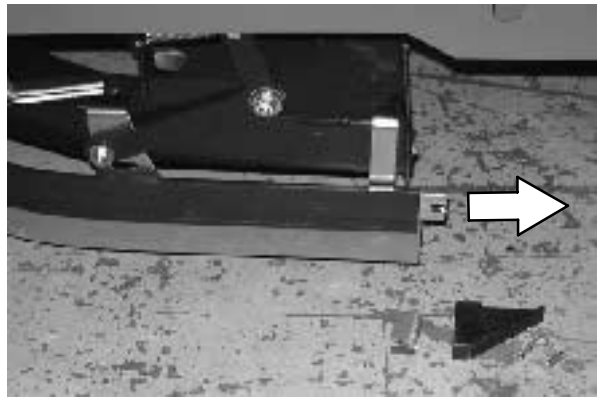

SKIRTS AND SEALS

PRE-SWEEP SIDE SKIRTS (OPTION)

The Pre-Sweep side skirts help direct debris into the debris hopper. The side skirts are located on both sides of the main sweeping brush in the Pre-Sweep assembly. The side skirts should be just touching the floor.

Check the skirts for damage and wear after every 50 hours of operation.

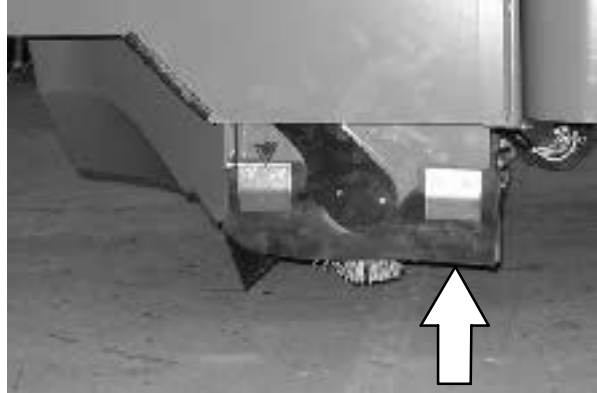
**PRE-SWEEP RECIRCULATION SKIRT (OPTION)**

The Pre-Sweep recirculation skirt is located behind the main sweeping brush.

Check the skirt for damage and wear after every 50 hours of operation.

**PRE-SWEEP REAR SKIRT (OPTION)**

The Pre-Sweep rear skirt is located behind the recirculation skirt and main sweeping brush.

Check the skirt for damage and wear after every 50 hours of operation.

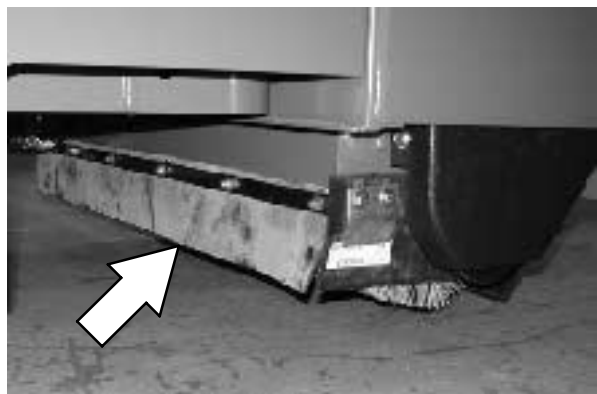

BELTS AND CHAINS

SCRUB BRUSH DRIVE BELTS

The two brush drive belts are located on the cylindrical brush scrub head. The belts drive the cylindrical brushes. Proper **new** belt tension is a 3 mm (0.1 in) deflection from a force of 1.37 to 1.48 kg (3.0 to 3.26 lb) at the belt midpoint.

When reusing an old belt, measure and record the belt tension before removal, so that the belt can be reinstalled at the same tension.

If the old belt tension was not recorded, the recommended force per old belts is 1.03 to 1.14 kg (2.28 to 2.52 lb) with a deflection of 3 mm (0.1 in).

Check the belt tension and wear every 100 hours of operation.

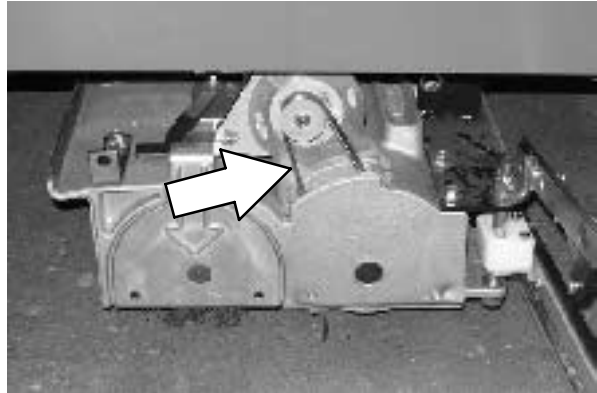

PRE-SWEEP BRUSH MOTOR BELT (OPTION)

The Pre-Sweep brush motor belt is located inside the Pre-Sweep assembly on the right hand side of the cylindrical brush. The belt drives the brush drive belt sheave. Proper belt tension is a 3 mm (0.12 in) deflection from a force of 0.6 to 0.64 kg (1.3 to 1.4 lb) at the belt midpoint.

Check the belt tension and wear every 100 hours of operation.

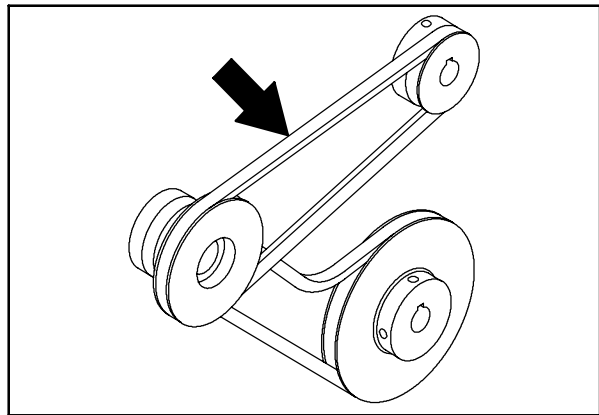

PRE-SWEEP BRUSH DRIVE BELT (OPTION)

The Pre-Sweep brush drive belt is located inside the Pre-Sweep assembly on the right side of the cylindrical brush. The belt drives the cylindrical brush. Proper belt tension is a 2 mm (.08 in) deflection from a force of 0.76 to 0.8 kg (1.7 to 1.8 lb) at the belt midpoint.

Check the belt tension and wear every 100 hours of operation.

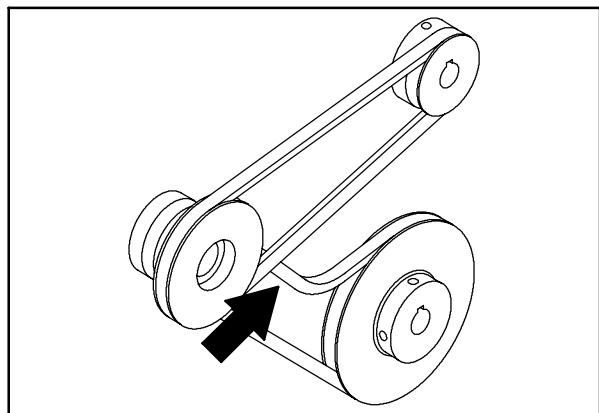

STATIC DRAG STRAP

The static drag strap prevents the buildup of static electricity in the machine. The strap is attached to the rear squeegee mounting channel.

Make sure the strap is always touching the floor.

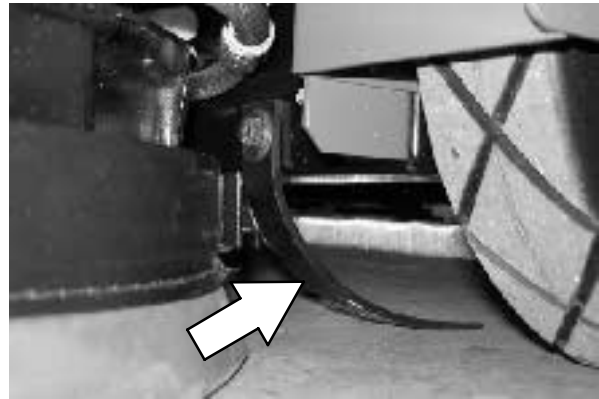
**STEERING GEAR CHAIN**

The steering gear chain is located directly above the front tire.

The steering gear chain tension should be checked after the first 50 hours of operation and every 500 hours thereafter. The proper deflection should be 3 to 6 mm (0.1 to 0.3 in) between the steering sprocket and the idler sprocket when the steering wheel is turned as far as it will go in either direction.

TIRES

The machine has three tires: one in front, and two in the rear of the machine. Torque the rear wheel nuts twice to 70 to 84 Nm (50 to 60 ft. lbs.) after the first 50 hours of operation, and every 1000 hours of operation. The tires are solid rubber. No maintenance is required.



PUSHING, TOWING, AND TRANSPORTING THE MACHINE

PUSHING OR TOWING THE MACHINE

If the machine becomes disabled, it can be pushed or towed from the front or rear.

The parking brake must be disabled before towing or pushing the machine. To disable the brake, pull the brake release lever to the guard and use a cable tie to secure the lever to the guard. The machine can move freely when the parking brake is disabled.

Only push or tow the machine for a *very short distance* and do not exceed 3.2 kp/h (2 mph). It is NOT intended to be pushed or towed for a long distance or at a high speed.

ATTENTION! Do not push or tow machine for a long distance or damage may occur to the propelling system.

Immediately after pushing the machine, remove the cable tie to enable the parking brake. Never operate the machine with the parking brake disabled.

FOR SAFETY: Do not operate machine with brake disabled.

TRANSPORTING THE MACHINE

1. Position the rear of the machine at the loading edge of the truck or trailer.

FOR SAFETY: Use truck or trailer that will support the weight of the machine.

NOTE: Empty the recovery and solution tanks before transporting the machine.



2. If the loading surface is not horizontal or is higher than 380 mm (15 in) from the ground, use a winch to load machine.

If the loading surface is horizontal AND is 380 mm (15 in) or less from the ground, the machine may be driven onto the truck or trailer.

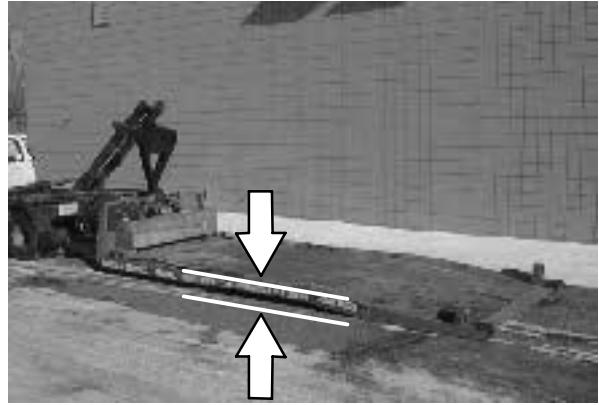

3. To winch the machine onto the truck or trailer, attach the winching chains to the rear tie down locations. The rear tie-down locations are the holes in the sides of the machine frame near the rear bumper.

FOR SAFETY: When loading machine onto truck or trailer, use winch. Do not drive the machine onto the truck or trailer unless the loading surface is horizontal AND is 380 mm (15 in) or less from the ground.

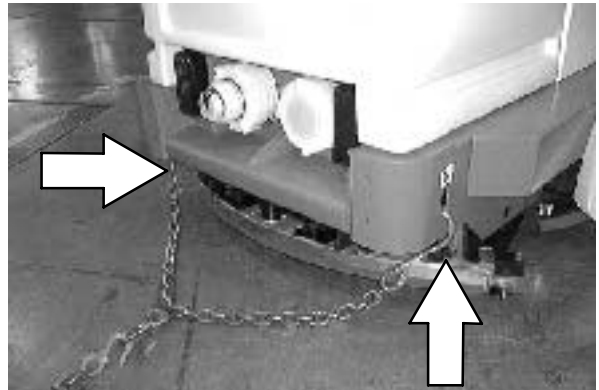

4. Position the machine onto the truck or trailer as far as possible. If the machine starts to veer off the center line of the truck or trailer, stop and turn the steering wheel to center the machine.
5. Lower the scrub head and block the machine tires. Tie down the machine to the truck or trailer before transporting.

The front tie-down locations are the holes in the front side of the machine frame.

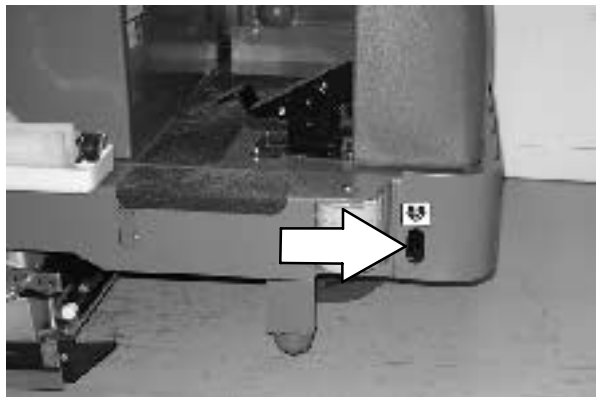

MAINTENANCE

The rear tie-down locations are the holes in the sides of the machine frame near the rear bumper.

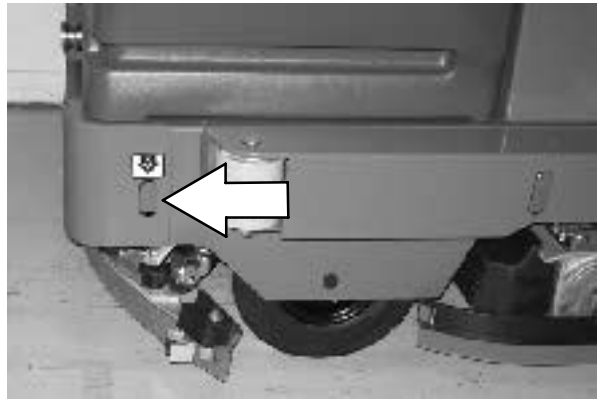

6. If the loading surface is not horizontal or is higher than 380 mm (15 in) from the ground, use a winch to unload machine.

If the loading surface is horizontal AND is 380 mm (15 in) or less from the ground, the machine may be driven off the truck or trailer.

FOR SAFETY: When unloading machine off truck or trailer, use winch. Do not drive the machine off the truck or trailer unless the loading surface is horizontal AND 380 mm (15 in) or less from the ground.

MACHINE JACKING

Empty the recovery solution tanks before jacking the machine. Jack up the machine from underneath all four corners of the machine. Use a hoist or jack that will support the weight of the machine. Use a piece of wood between the jack and frame to distribute the machine weight load.

Always stop the machine on a flat level surface and block the tires before jacking the machine up.

FOR SAFETY: When servicing machine, block machine tires before jacking machine up.

FOR SAFETY: When servicing machine, jack machine up at designated locations only. Block machine up with jack stands.

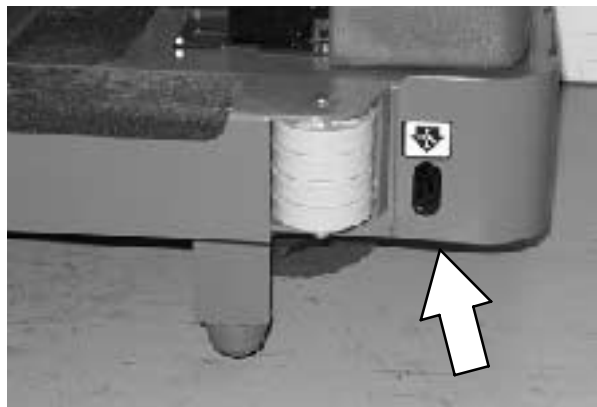

STORAGE INFORMATION

The following steps should be taken when storing the machine for extended periods of time.

1. Drain and clean the solution and recovery tanks.

ES machines: Run clean water through the solution system and the ES solution pump.
2. Park the machine in a cool, dry area.
3. Remove the batteries, or charge them every three months.

FREEZE PROTECTION

1. Drain the solution tank and recovery tank of all water.
2. Pour 1 gallon (3.8 liters) of Propylene Glycol Based / Recreational Vehicle (RV) Antifreeze into the solution tank at full strength. Do not dilute.
3. Turn the machine power on and operate the solution flow system. Turn the machine off when the antifreeze appears at the scrub head.

If your machine is equipped with the off-aisle wand option, operate the the off-aisle wand for a few seconds to protect the pump.

Continue with the freeze protection procedure if machine is equipped with the *ec-H2O* system.

MAINTENANCE

ec-H2O MODEL:

4. Press and release the flush switch on the *ec-H2O* module to cycle the antifreeze through *ec-H2O* system. When the antifreeze appears at the scrub head, press the switch again to turn off the module.

IMPORTANT: Before operating the machine, the antifreeze must be flushed from the module as described below.

ATTENTION: If the antifreeze is not properly flushed from the *ec-H2O* system, the *ec-H2O* module may detect an error and not function (*ec-H2O* switch indicator light will turn red). If this occurs, reset key and repeat the flush procedure as described below.

FLUSHING ANTIFREEZE FROM ec-H2O MODULE:

1. Drain the antifreeze from the solution tank into a bucket.
2. Fill the solution tank with cool water until full (See FILLING SOLUTION TANK).
3. Disconnect the connector fitting and place the hose into a bucket.
4. Press and release the *ec-H2O* module switch to flush the antifreeze from the *ec-H2O* system. The module is located behind the cover.

When the water turns clear, press the module switch again to stop the flush cycle.

Dispose the antifreeze in an environmentally safe way according to local waste disposal regulations.

5. The machine is now ready for scrubbing.

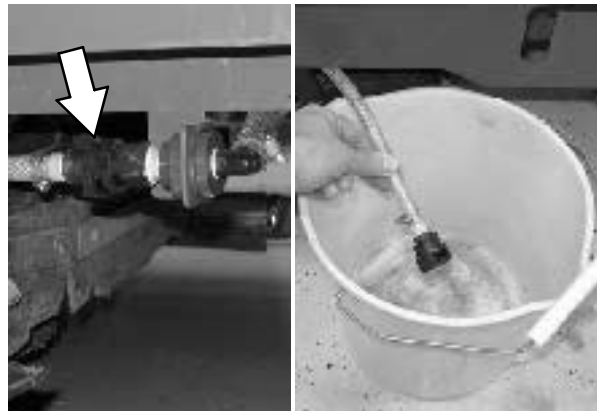
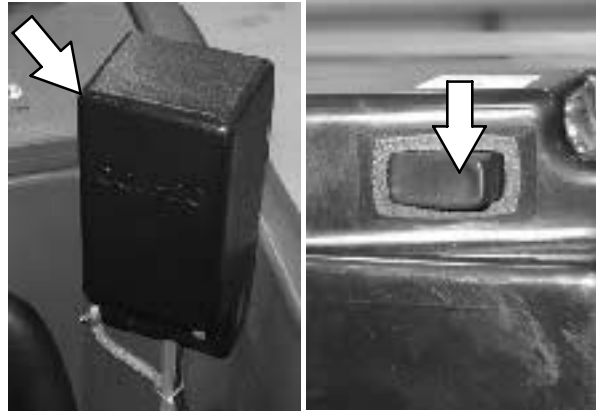

SPECIFICATIONS

GENERAL MACHINE DIMENSIONS/CAPACITIES

| Item | Dimension/capacity |
|---|--------------------|
| Length | 1830 mm (72 in) |
| Length (with Pre-Sweep) | 2465 mm (97 in) |
| Width (less squeegee) | 1025 mm (40.25 in) |
| Width (with squeegee) | 1155 mm (45.5 in) |
| Height | 1360 mm (53.5 in) |
| Height with overhead guard | 2030 mm (80 in) |
| Disk brush diameter for side brush (option) | 460 mm (18 in) |
| Disk brush diameter for Pre-Sweep (option) | 380 mm (15 in) |
| Disk brush diameter for 700 mm (28 in) scrub head | 355 mm (14 in) |
| Disk brush diameter for 900 mm (36 in) scrub head | 460 mm (18 in) |
| Cylindrical sweep brush diameter for Pre-Sweep (option) | 155 mm (6 in) |
| Cylindrical sweep brush length for Pre-Sweep (option) | 810 mm (32 in) |
| Cylindrical scrub brush diameter | 155 mm (6 in) |
| Cylindrical brush length for 700 mm (28 in) scrub head | 700 mm (28 in) |
| Cylindrical brush length for 900 mm (36 in) scrub head | 900 mm (36 in) |
| Squeegee width for 700 mm (28 in) scrub head | 950 mm (37.5 in) |
| Squeegee width for 900 mm (36 in) scrub head | 1155 mm (45.5 in) |
| Scrubbing path width for 700 mm (28 in) scrub head | 710 mm (28 in) |
| Scrubbing path width for 900 mm (36 in) scrub head | 915 mm (36 in) |
| Solution tank capacity | 170 L (45 gallons) |
| Recovery tank capacity | 210 L (55 gallons) |
| GVWR | 1134 Kg (2500 lbs) |

GENERAL MACHINE PERFORMANCE

| Item | Measure |
|--|-------------------|
| Aisle turnaround width | 2080 mm (82 in) |
| Aisle turnaround width (with Pre-Sweep) | 2770 mm (109 in) |
| Travel Speed | 9.6 Km (6 mph) |
| Maximum rated climb and descent angle for transport | 8° @ gross weight |
| Maximum rated climb and descent angle for scrubbing | 4° |
| Maximum rated climb and descent angle for trailering | 11° |

SPECIFICATIONS

POWER TYPE

| Type | Quantity | Volts | Ah Rating | Weight |
|-----------|----------|-------|------------------|----------------|
| Batteries | 6 | 6 | 235 @ 20 hr rate | 30 kg (67 lb) |
| | 6 | 6 | 335 @ 20 hr rate | 47 kg (104 lb) |

| Type | Use | VDC | kW (hp) |
|-----------------|---------------------------|-----|-------------|
| Electric Motors | Pre-Sweep brush (disk) | 36 | 0.20 (0.25) |
| | Pre-Sweep brush (cyl) | 36 | 0.45 (0.60) |
| | Scrub brush (disk) | 36 | 0.55 (0.75) |
| | Scrub brush (cylindrical) | 36 | 0.55 (0.75) |
| | Vacuum fan | 36 | 0.6 (0.8) |
| | Propelling | 36 | 1.1 (1.5) |

| Type | VDC | amp | Hz | Phase | VAC |
|------------------|-----|-----|-------|-------|--------|
| Chargers (Smart) | 36 | 21 | 45-65 | 1 | 85-265 |

TIRES

| Location | Type | Size |
|-----------|-------|---|
| Front (1) | Solid | 100 mm wide x 305 mm OD (4 in wide x 12 in OD) |
| Rear (2) | Solid | 90 mm wide x 305 mm OD (3.5 in wide x 12 in OD) |

FaST SYSTEM

| Item | Measure |
|-----------------------------------|--|
| Solution pump | 36 Volt DC, 5A, 5.7 LPM (1.5 GPM) open flow, 45 psi bypass setting |
| Solution flow rate | 1.1 LPM (0.30 GPM) |
| Detergent to water dilution ratio | 1:1000 |
| Detergent flow rate | 1.14 CC/Minute (0.038 Ounces/Minute) |

ec-H2O SYSTEM (OPTION)

| Item | Measure |
|-----------------------------------|--|
| Solution pump | 36 Volt DC, 5A, 5.7 LPM (1.5 GPM) open flow, 45 psi bypass setting |
| Solution flow rate* - disk | 1.14 LPM (0.30 GPM) (standard) 1.51 LPM (0.40 GPM) (optional) 1.89 LPM (0.50 GPM) (optional) |
| Solution flow rate* - cylindrical | 1.14 LPM (0.30 GPM) (optional) 1.51 LPM (0.40 GPM) (standard) 1.89 LPM (0.50 GPM) (optional) |

*If the optional solution flow rates are required, contact an Authorized Service Center.

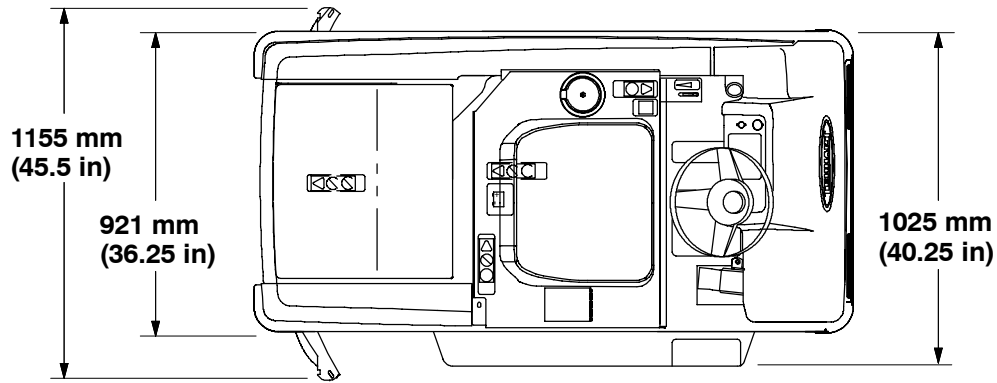

TOP VIEW

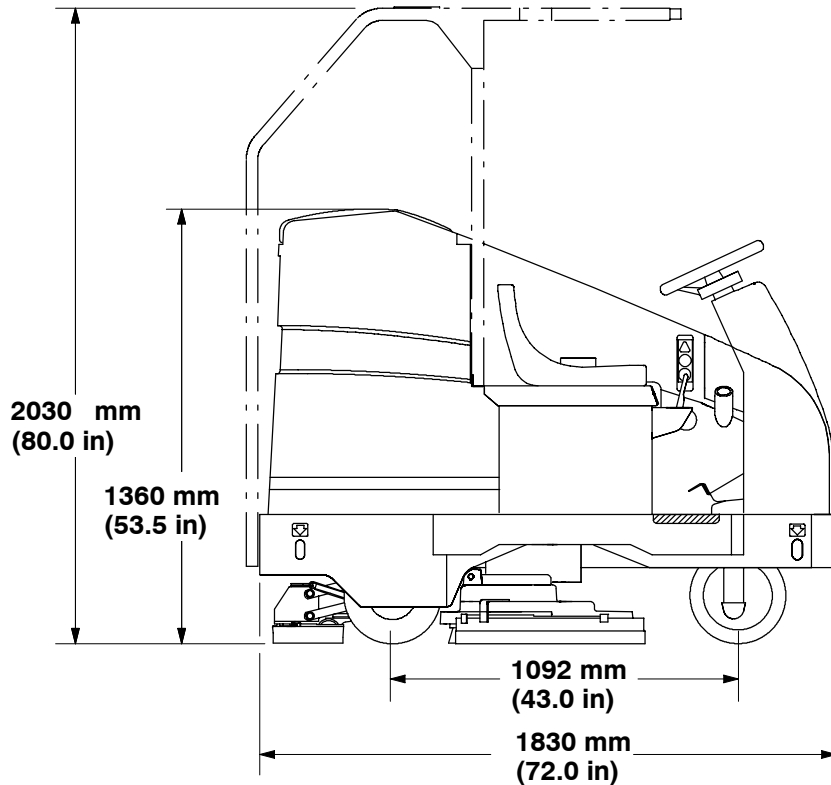

SIDE VIEW

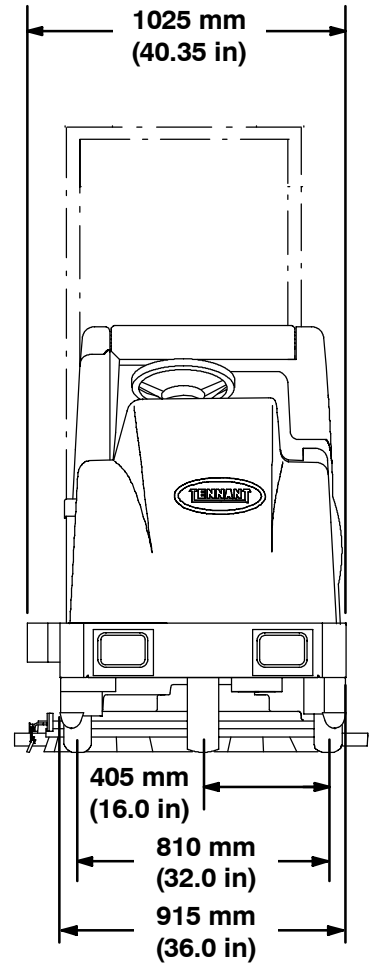

FRONT VIEW

350790

MACHINE DIMENSIONS

B

Batteries, 66
 Charging the batteries, 67
 Maintenance, 66
 Measuring specific gravity, 67
 Rollout Battery, 56
 Specifications, 106

Battery discharge indicator, 15

Belts, Scub brush drive belts, 98

Belts and chains, 98
 Pre-Sweep brush drive belt (option), 98
 Pre-Sweep brush motor belt, 98

Brake pedal, 9

Brush Information, 20

C

Capacities, 105

Chain, steering gear, 99

Circuit breakers, 17

Cleaning the FaST System Check Valves, 88

Control panel, 13, 14
 Self-diagnostic test, 70
 Symbols, 6

Controls
 Brake pedal, 9
 Circuit breakers, 17
 Directional pedal, 8
 Dust control switch (option), 16
 ec-H20 switch (option), 14
 ES switch (option), 13
 FaST switch (option), 13
 Fuse, 18
 Hourmeter, 10
 Key switch, 10
 Operating lights switch, 10
 Operation of controls, 8
 Parking brake, 9
 Power shutdown switch, 10
 Pre-Sweep switch (option), 16
 Scrubbing switch, 12
 Side brush pedals (option), 16
 Solution flow lever, 11
 Squeegee switch, 13
 Steering wheel, 18

Controls and instruments, 7

Cylindrical brushes, Replacing brushes, 84

Cylindrical scrub brushes, Checking and adjusting brush pattern, 81

D

Debris trough, 39

Diagnostics, Self-Diagnostic test, 70

Dimensions, 105

Directional pedal, 8

Disable the parking brake, 100

Draining and cleaning tanks, 36

Dust control switch (option), 16

E

ec-H20 Module Freeze Protection, Flush Antifreeze From ec-H20 Module, 104

ec-H20 Module Flush Procedure, 89

ec-H20 Scrubbing System, 23
 Indicator Light Codes, 31

ec-H20 Scrubbing System Indicator Light Codes , 31

ec-H20 switch, 14

ec-H20 System Specifications, 106

Electric motors, 72

Electrical system
 Batteries, 66
 Charging the batteries, 67
 Circuit breakers, 17
 Fuse, 18

ES mode (option)
 Draining and cleaning tank, 37, 38
 ES switch, 13

ES switch (option), 13

F

FaST, 25

FaST Scrubbing System, 22
 Installing FaSt Pak Agent, 25

FaST Supply Hose Connector, 87

FaST switch, 13

FaST System, 87
 Cleaning the FaST System Check Valves, 88
 Specifications, 106

FaST System Air Pump Filter, 88

FaST System Filter Screen, 88

Filling the tanks, 27

Filter

- FaST System Air Pump Filter, 88

- FaST System Filter Screen, 88

- Flush Antifreeze From ec-H2O Module, 104

- Flush Procedure, ec-H2O Module, 89

- Freeze protection, Storage, 103

- ec-H2O, 104

- Fuse, 18

H

- Hourmeter, 10

- How the machine works, 20

I

- Inclines, Operating on inclines, 9

- Indicator Light Codes, ec-H2O Scrubbing System, 31

- Indicators

- Battery discharge, 15

- ec-H2O Indicator, 14

- ES Indicator, 13

- FaST Indicator, 13

- Recovery tank full, 14

- Scrub switch indicator, 12

- Squeegee switch indicator, 13

- Installing FaSt Pak Agent, 25

J

- Jacking machine up, 102

K

- Key switch, 10

L

- Lights, Operating lights switch, 10

- Lubrication, 65

- Rear squeegee casters, 65

- Steering caster pivot bearing, 65

- Steering gear chain, 65

M

- Machine components, 5

- Machine dimensions, 107

- Machine operation

- Double scrubbing, 33

- How the machine works, 20

- Pre-operation checklist, 24

- Scrubbing, 29

- Starting the machine, 26

- Stop scrubbing, 34

- Stopping the machine, 40

- Troubleshooting, 61

- Machine performance

- Aisle turnaround width, 105

- Climb and descent angles, 105

- Machine specifications, 105–108

- Machine tie down location, 101

- Maintenance, 63

- Adjusting rear squeegee blade deflection, 92

- Adjusting squeegee guide rollers, 93

- Batteries, 66

- Belts and chains, 98

- Charging batteries, 67

- Checking and adjusting Pre-Sweep brush pattern, 74

- Checking and adjusting scrub brush pattern, 81

- Cylindrical scrub brushes, 81

- Disk scrub brushes, 78

- ec-H2O Module Flush Procedure, 89

- Electric motors, 72

- FaST System, 87

- Leveling the rear squeegee, 91

- Lubrication, 65

- Pre-Sweep brush drive belt (option), 98

- Pre-Sweep brush motor belt, 98

- Pre-Sweep brushes, 72

- Pre-Sweep cylindrical brushes, 74

- Pre-Sweep disk brushes, 72

- Pre-Sweep rear skirt (option), 97

- Pre-Sweep recirculation skirt, 97

- Pre-Sweep side skirts (option), 97

- Rear squeegee assembly, 90–93

- Rear squeegee assembly removal, 90

- Rear squeegee assembly replacement, 91

- Rear squeegee blades, 93

- Rear squeegee rotation and replacement, 93

- Recovery tank, 86

- Replacing cylindrical brushes, 84

- Replacing disk scrub brushes, 78

- Replacing or rotating front squeegee blade, 95

- Replacing Pre-Sweep cylindrical brushes, 76

- Replacing side squeegee blades, 96

- Replacing sweep disk brushes, 72

Scheduled intervals, 63
Scrub brush drive belts, 98
Scrub brushes, 78
Self-Diagnostic test, 70
Side squeegee blades, 96
Skirts and seals, 97
Solution system, 86
Solution tank, 87
Maintenance chart, 63
Motors, Electric motors, 72

O

Operating lights switch, 10
Operating on inclines, 9
Operator seat, 11
Options, 41
 Dust control switch, 16
 ec-H2O Scrubbing System, 23
 ES (Extended Scrub) switch, 13
 FaST Scrubbing System, 22
 Installing FaSt Pak Agent, 25
 Positive drain control valve, 55
 Power wand, 48
 Pre-Sweep, 42
 Pre-Sweep assembly
 Installation, 46
 Removal, 45
 Pre-Sweep debris hopper, 43
 Pre-Sweep switch, 16
 Rollout Battery, 56
 Side brush, 41
 Vacuum wand, 52

P

Parking brake, 9
 Disable the parking brake, 100
Pedals
 Brake pedal, 9
 Directional, 8
 Operating on inclines, 9
 Side brush pedals (option), 16
Positive drain control valve (option), 55
Power shutdown switch, 10
Power wand (option), 48
Pre-operation checklist, 24
Pre-Sweep (option), 42
 Dust control switch, 16
 Emptying the debris hopper, 43
 Pre-Sweep switch, 16

Pre-Sweep assembly
 Installation, 46
 Removal, 45
Pre-Sweep assembly installation, 46
Pre-Sweep assembly removal, 45
Pre-Sweep brushes, 72
 Adjusting Pre-Sweep cylindrical brush pattern, 74
 Checking Pre-Sweep cylindrical brush pattern, 74
 Cylindrical brush, 74
 Disk brushes, 72
Pre-Sweep cylindrical brush
 Checking and adjusting brush pattern, 74
 Replacing brush, 76
Pre-Sweep switch (option), 16
Pushing machine, 100
Pushing or towing the machine, 100
Pushing, towing, and transporting machine, 100

R

Rear squeegee
 Adjusting blade deflection, 92
 Leveling, 91
 Rotating or replacing blades, 93
Rear squeegee assembly, 90
 Removal, 90
 Replacement, 91
Rear squeegee blades, 93
Recovery tank, 86
Recovery tank full indicator, 14
Replacing disk brushes, 72
Replacing disk scrub brushes, 78
Rollout Battery (option), 56

S

Safety
 Labels, 5
 Precautions, 4
Screen, FaST System Filter Screen, 88
Scrub brushes, 78
 Adjusting cylindrical scrub brush pattern, 81
 Checking cylindrical scrub brush pattern, 81
 Cylindrical brushes, 81
 Disk scrub brushes, 78
 Replacing cylindrical brushes, 84
 Replacing disk scrub brushes, 78

- Scrubbing, 29
 - Double scrubbing, 33
 - Scrubbing with power wand (option), 48
 - Stop scrubbing, 34
 - Scrubbing switch, 12
 - Seat
 - Adjustment lever, 11
 - Operator, 11
 - Seat support arm, 11
 - Side brush (option), 41
 - Side brush pedals (option), 16
 - Side squeegee, Side squeegee down pressure controls, 19
 - Side squeegee blades, 96
 - Replacement, 96
 - Side squeegee down pressure controls, 19
 - Skirts and seals, 97
 - Pre-Sweep rear skirt (option), 97
 - Pre-Sweep recirculation skirt, 97
 - Pre-Sweep side skirts (option), 97
 - Solution flow lever, 11
 - Solution system, 86
 - Solution tank, 87
 - Filling the tank, 27
 - Specifications, 105–108
 - Battery chargers, 106
 - ec-H2O System, 106
 - Electric motors, 106
 - FaST System, 106
 - Machine capacities, 105
 - Machine dimensions, 105
 - Machine performance, 105
 - Power type, 106
 - Tires, 106
 - Squeegee
 - Adjusting deflection, 19
 - Adjusting guide rollers, 93
 - Front blade rotation or replacement, 95
 - Leveling knob, 19
 - Recommended amount, 92
 - Squeegee leveling knob, 19
 - Squeegee switch, 13
 - Squeegee wheel cams, 19
 - Starting the machine, 26
 - Steering wheel, 18
 - Stopping the machine, 40
 - Storage information, 103
 - Freeze protection, 103
 - ec-H2O, 104
 - Strap, static drag, 99
 - Sweep brushes
 - Replacing disk brushes, 72
 - Replacing Pre-Sweep cylindrical brushes, 76
 - Sweeping, Sweeping with side brush (option), 41
 - Switches
 - Dust control switch (option), 16
 - ec-H2O switch, 14
 - ES switch (option), 13
 - FaST switch, 13
 - Key switch, 10
 - Operating lights switch, 10
 - Power shutdown switch, 10
 - Pre-Sweep switch (option), 16
 - Scrubbing switch, 12
 - Squeegee switch, 13
 - Symbols, Control panel, 6
- T**
- Tanks
 - Draining and cleaning tanks, 36–39
 - Filling the tanks, 27
 - Recovery tank, 86
 - Solution tank, 87
 - Tie down location, 101
 - Tires, 99
 - Specifications, 106
 - Towing machine, 100
 - Transporting machine, 100
 - Transporting the machine, 100
 - Troubleshooting, 61
- V**
- Vacuum wand (option), 52

